

MİMARİ KATALOG
ARCHITECTURAL CATALOGUE

Alüminyum Kapı Pencere ve Giydirme Cephe Sistemleri
Aluminium Window Doors and Facade Systems

RESCARA



RW46

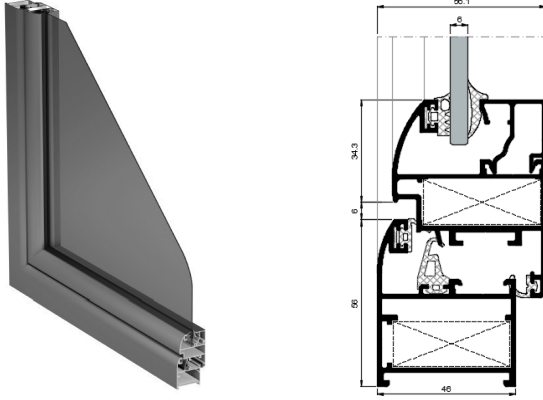

TEKNİK ÖZELLİKLERİ / TECHNICAL PROPERTIES

KASA DERİNLİĞİ / <i>FRAME DEPTH</i>	46 mm
KANAT DERİNLİĞİ / <i>VENT DEPTH</i>	51,6 / 46 / 51,2 mm
PROFİL ET KALINLIĞI / <i>PROFILE GLASS THICKNESS</i>	1,4 mm
MAX. CAM KALINLIĞI / <i>MAX. GLASS THICKNESS</i>	22 mm

KULLANIM SEÇENEKLERİ / APPLICATION ALTERNATIVES

	KAPI DOOR	PENCERE WINDOW
İÇE AÇILIR / <i>INWARD OPENING</i>	*	*
DIŞA AÇILIR BİNLİ / <i>OUTWARD OPENING</i>	*	
VASİSTAS / <i>BOTTOM HUNG</i>		*
DIŞA - İÇE AÇILIR HEMYÜZ KAPI / <i>OUTWARD-INWARD OPENING COPLANAR DOOR</i>	*	
ÇİFT EKSEN AÇILIM / <i>TILT&TURN OPENING</i>	*	*
PVC AKSESUAR İÇİN KANAT / <i>VENT FOT PVC ACCESSORIES</i>	*	*

MİMARİ KATALOG

ARCHITECTURAL CATALOGUE

Alüminyum Kapı Pencere ve Giydirme Cephe Sistemleri
Aluminium Window Doors and Facade Systems



Rescara Sistem Detayları
Rescara System Details

RW46

PROFİLLER

PROFILES

01

02

03

04

05

06

07

08

09

10

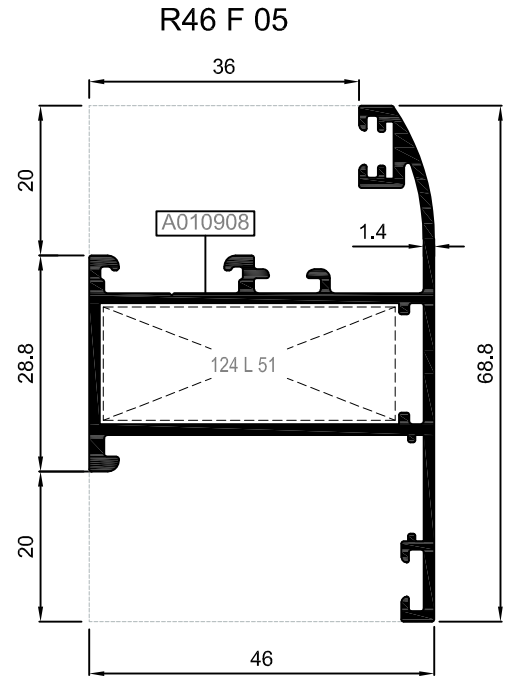
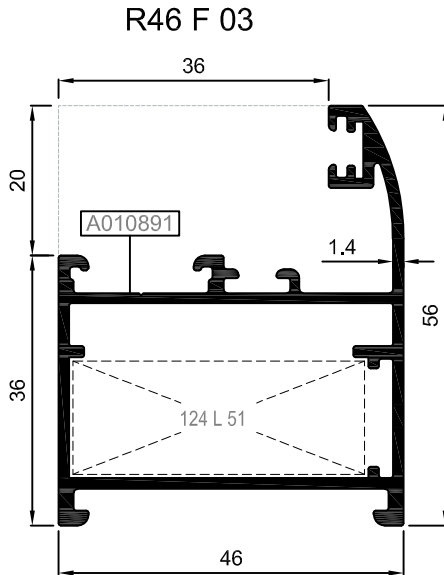
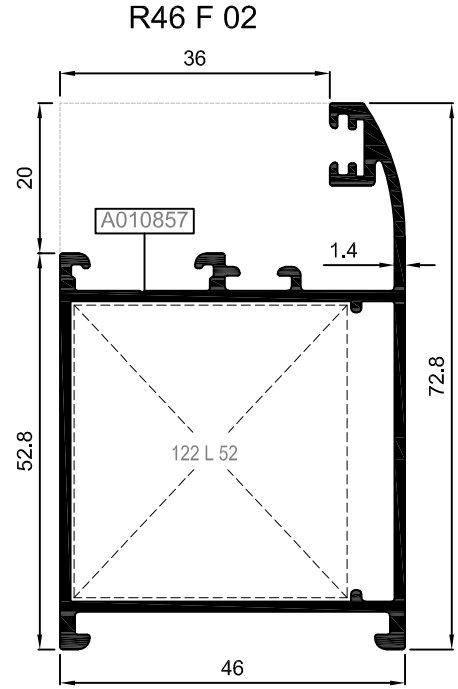
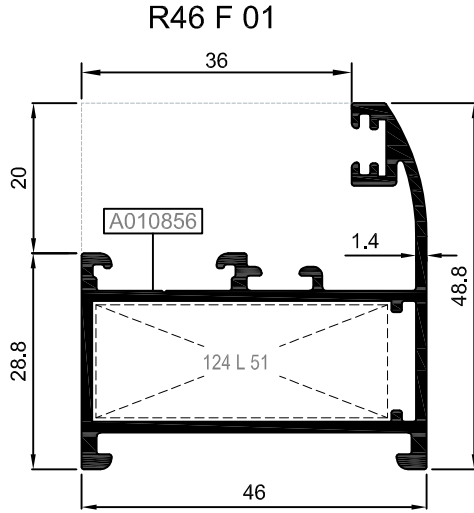
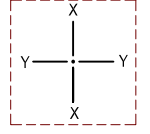

KOD/ CODE	AĞIRLIK (kg/m)/ WEIGHT	Jxx cm4	Jyy cm4	L m
R46 F 01	0,827	8,533	5,419	6
R46 F 02	1,003	11,918	18,074	6
R46 F 03	0,907	9,939	8,264	6
R46 F 05	0,914	9,556	8,853	6

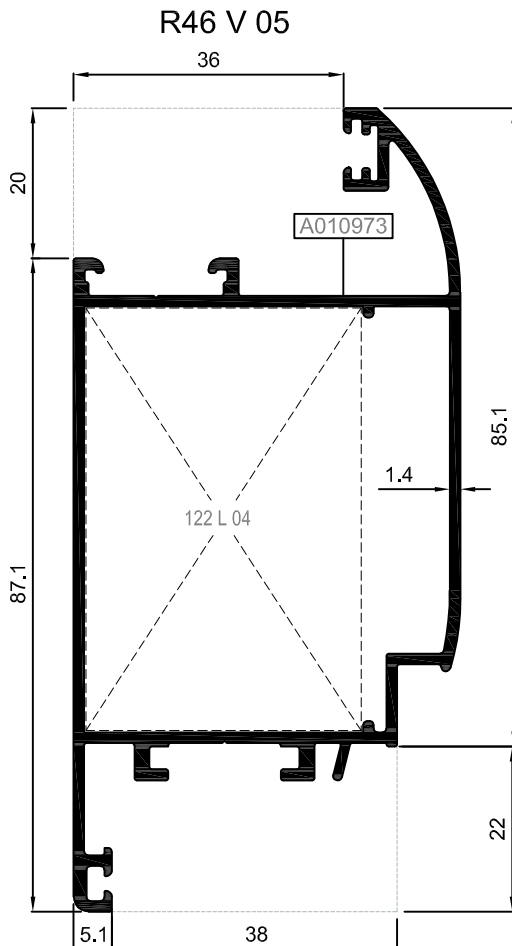
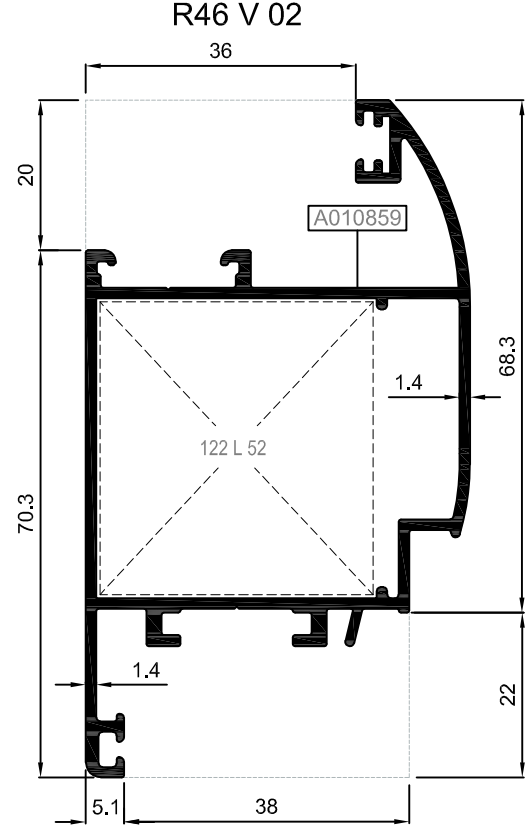
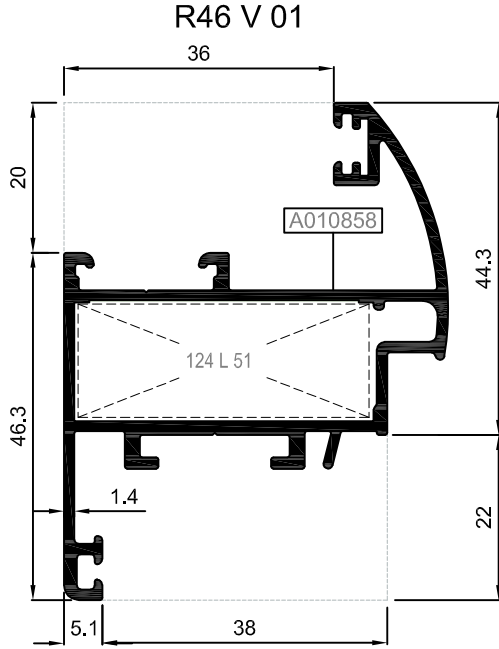
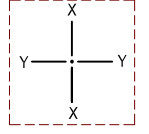

Nr		L m	KESİM ÖLÇÜSÜ CUTTING SIZE	AKS. KODU ACS. CODE
R46 F 01	A010856	25 L 51 (A010887)	39,3 mm	124 L 51
R46 F 03	A010891			
R46 F 05	A010908			
R46 F 02	A010857	25 L 52 (A010888)	36,7 mm	122 L 52

KOD/ CODE	AĞIRLIK (kg/m)/ WEIGHT	Jxx cm ⁴	Jyy cm ⁴	L m
R46 V 01	1,011	11,784	9,210	6
R46 V 02	1,190	15,826	26,390	6
R46 V 05	1,315	19,086	46,297	6



Nr		 L m	KESİM ÖLÇÜSÜ CUTTING SIZE	 AKS. KODU ACS. CODE
R46 V 01	A010858	25 L 51 (A010887)	39,3 mm	124 L 51
R46 V 02	A010859	25 L 52 (A010888)	36,7 mm	122 L 52
R46 V 05	A010973	25 L 04 (A002211)	36,7 mm	122 L 04

KOD/ CODE	AĞIRLIK (kg/m)/ WEIGHT	Jxx cm4	Jyy cm4	L m
R46 V 03	1,204	15,071	37,926	6
R46 V 04	1,204	14,263	37,934	6

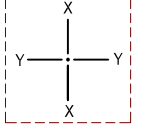

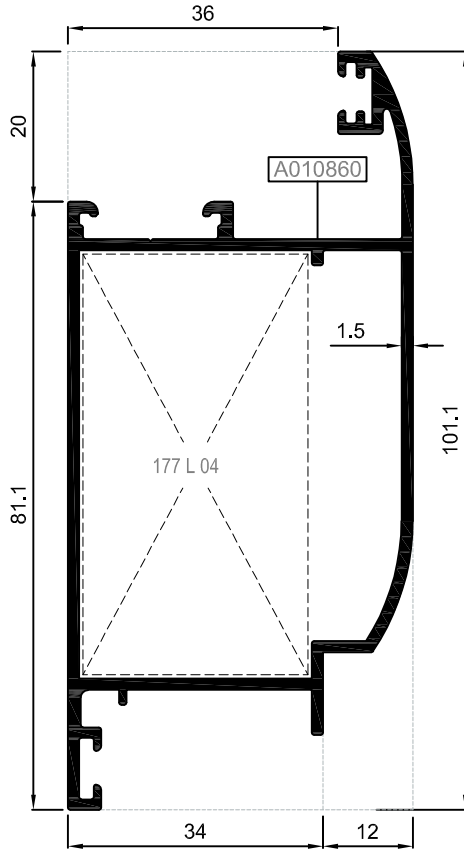

R46 V 03 (HEMYÜZ)

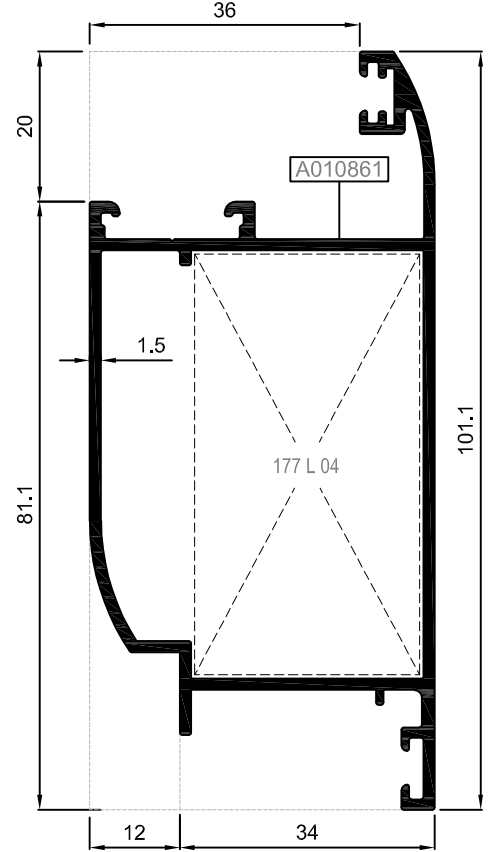

R46 V 04 (HEMYÜZ)





Nr		 L m	KESİM ÖLÇÜSÜ	 PARÇA KOD NUMARASI
R46 V 03	A010860	25 L 04 (A002211)	30,7 mm	177 L 04
R46 V 04	A010861	25 L 04 (A002211)	30,7 mm	177 L 04

KANAT VE ADAPTÖR PROFİLLERİ (PVC AKSESUARA UYGUN - 9 AKS) VENT AND ADAPTER PROFILES (FOR PVC ACCESSORY - 9 AXLE)

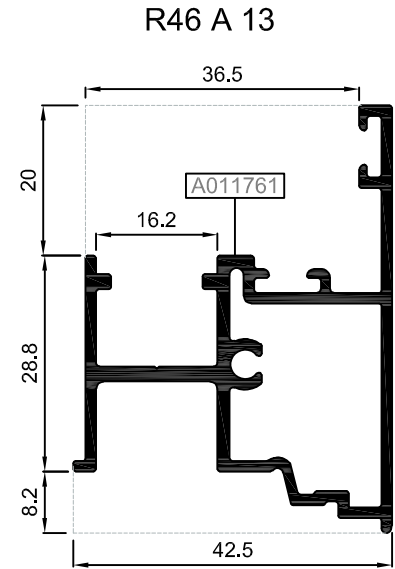
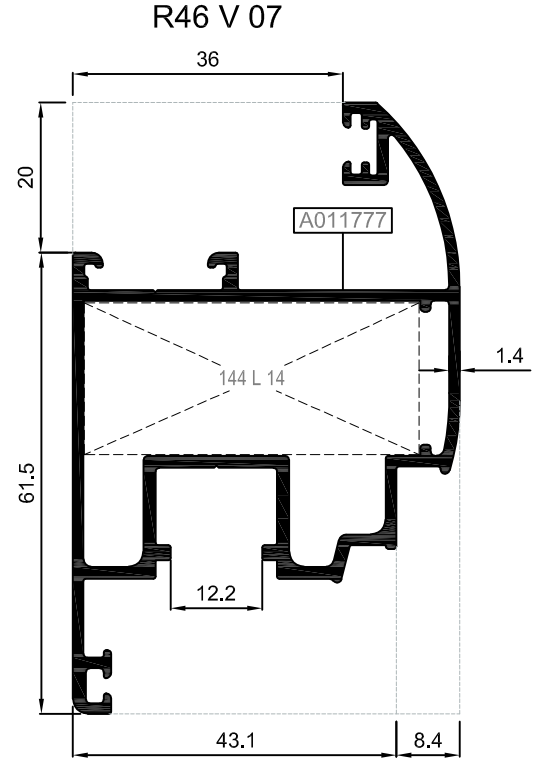
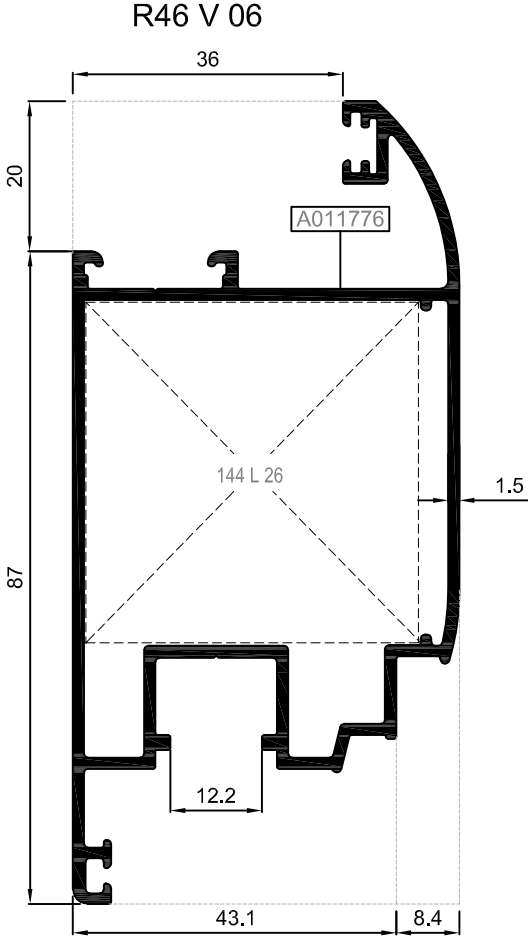
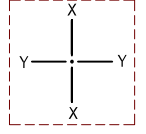



KOD/ CODE	AĞIRLIK (kg/m)/ WEIGHT	Jxx cm4	Jyy cm4	L m
R46 V 06	1,447	20,376	47,869	6
R46 V 07	1,216	15,044	19,012	6
R46 A 13	0,856	----	----	6

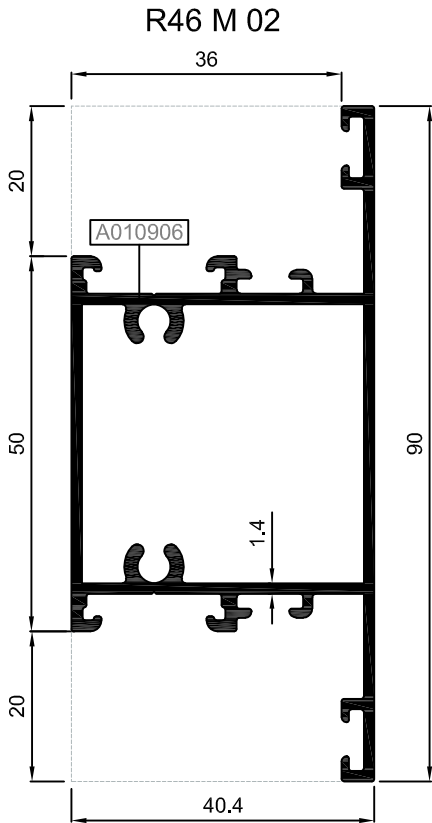
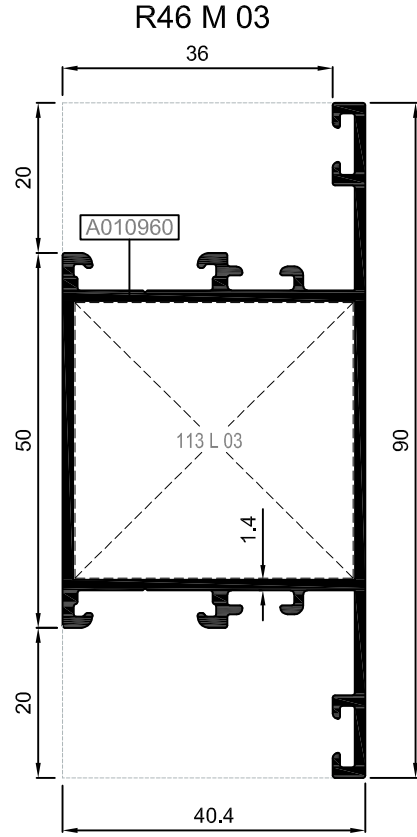
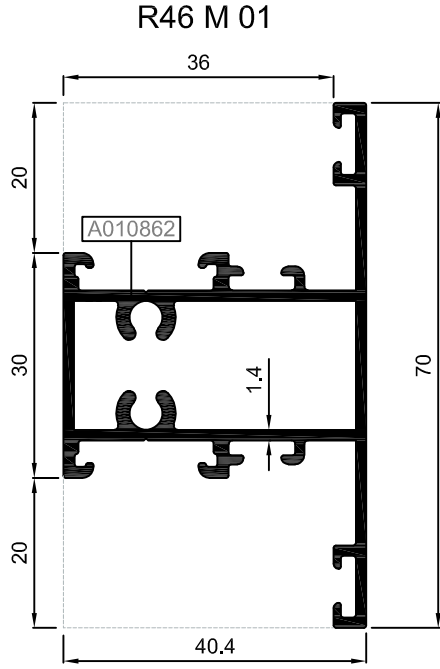
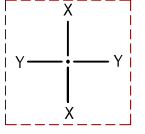

Nr		 L m	KEŞİM ÖLÇÜSÜ	 PARÇA KOD NUMARASI
R46 V 06	A011776	25 L 26 (A010540)	44,4 mm	144 L 26
R46 V 07	A011777	25 L 14 (A002059)	44,4 mm	144 L 14

KOD/ CODE	AĞIRLIK (kg/m)/ WEIGHT	Jxx cm4	Jyy cm4	L m
R46 M 01	0,975	7,752	8,326	6
R46 M 02	1,128	9,905	21,308	6
R46 M 03	1,019	9,241	20,224	6



Nr	 L m	KESİM ÖLÇÜSÜ	 PARÇA KOD NUMARASI	
R46 M 03	A010960	25 L 03 (A002021)	37,1 mm	113 L 03
Nr	 L m	KESİM ÖLÇÜSÜ CUTTING SIZE	 AKS. KODU ACS. CODE	
R46 M 03	A010960	25 J 13 (A010959)	36,9 mm	307 J 13

ETEK, ADAPTÖR VE TİJ PROFİLLERİ
KICK PLATE, ADAPTER AND SLIDING ROD PROFILES

RW46

KOD/ CODE	AĞIRLIK (kg/m)/ WEIGHT	Jxx cm ⁴	Jyy cm ⁴	L m
R46 K 01	1,353	14,112	65,392	6
R46 A 02	0,825	5,976	7,239	6
R46 A 03	0,473	---	---	6
25 I 07	0,143	---	---	6
25 I 04	0,153	---	---	6

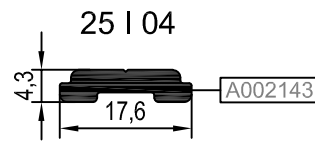
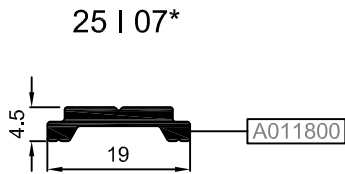
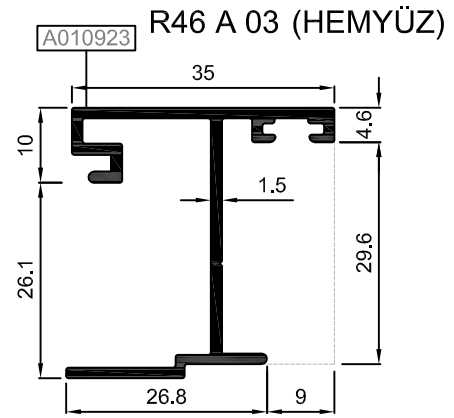
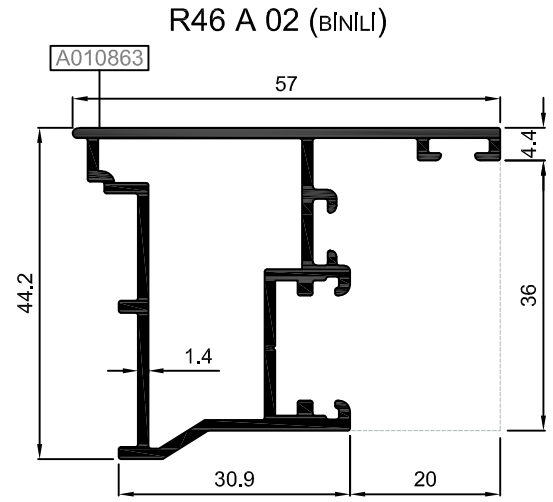
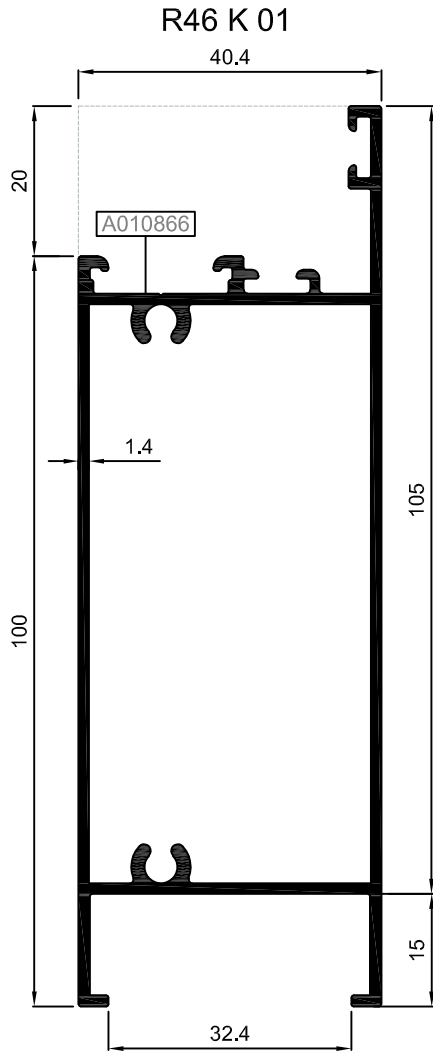
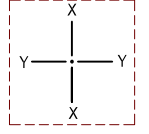

***Giesse kol ve kilitleme aksesuarları sadece 25 I 07 tij profili ile kullanılmalıdır.
Giesse handle and locking accessories should be used with only 25 I 07 rod profile

ADAPTÖR PROFİLLERİ ADAPTER PROFILES

RW46

KOD/ CODE	AĞIRLIK (kg/m)/ WEIGHT	Jxx cm4	Jyy cm4	L m
R46 A 04	0,229	----	----	6
R46 A 07	0,475	----	----	6
R46 A 12	0,686	----	----	6

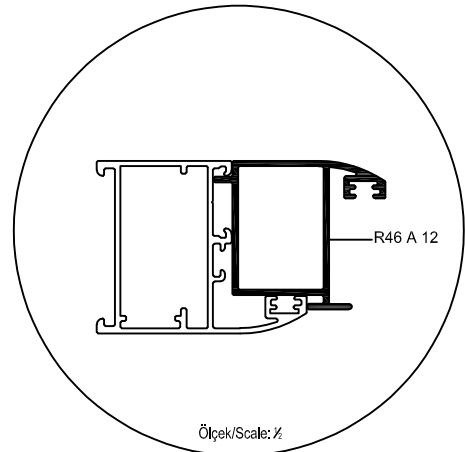
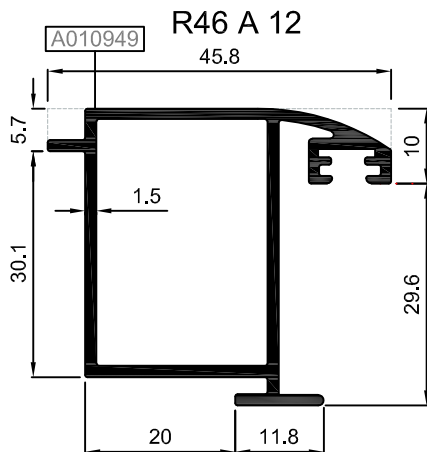
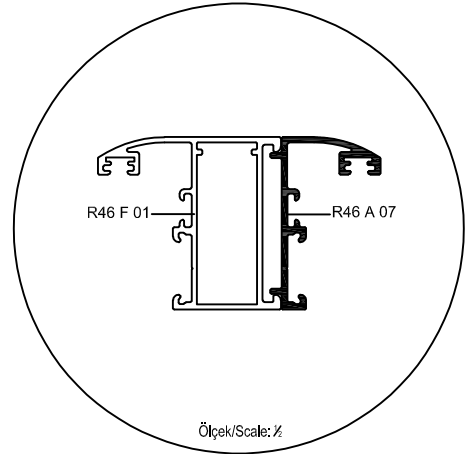
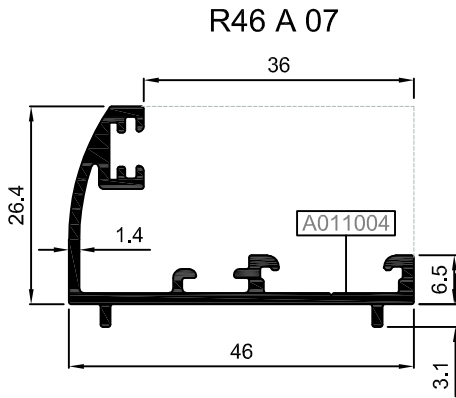
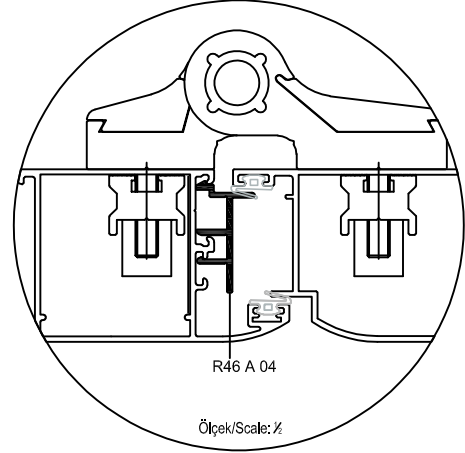
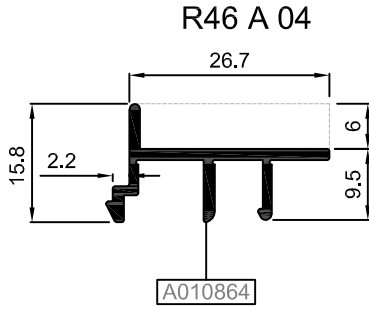
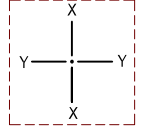

ADAPTÖR PROFİLLERİ
ADAPTER PROFILES

RW46

KOD/ CODE	AĞIRLIK (kg/m)/ WEIGHT	Jxx cm4	Jyy cm4	L m
R46 A 09	0,417	----	----	6
A001185	0,556	----	----	6
46 D 01	0,902	----	----	6

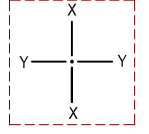

R46 A 09

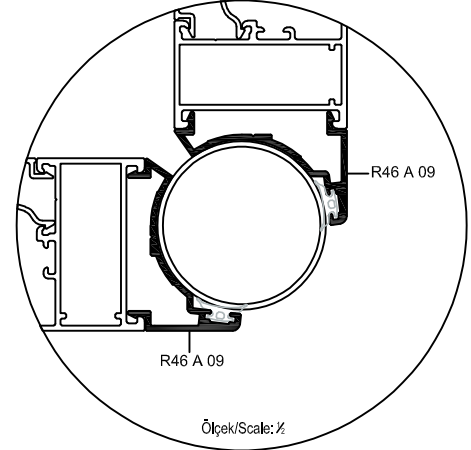
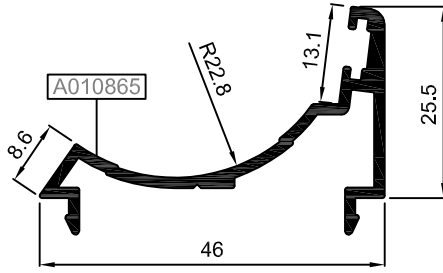

A001185

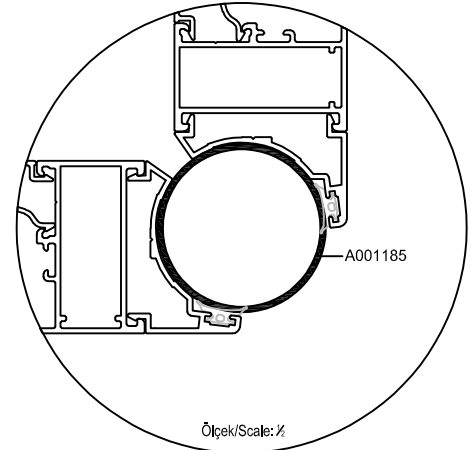
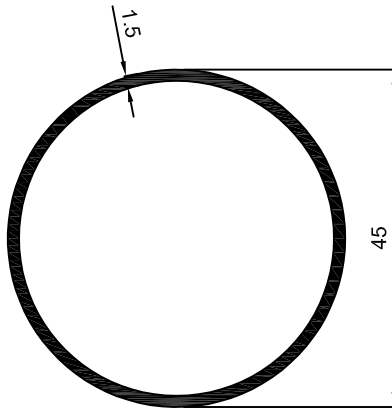

46 D 01

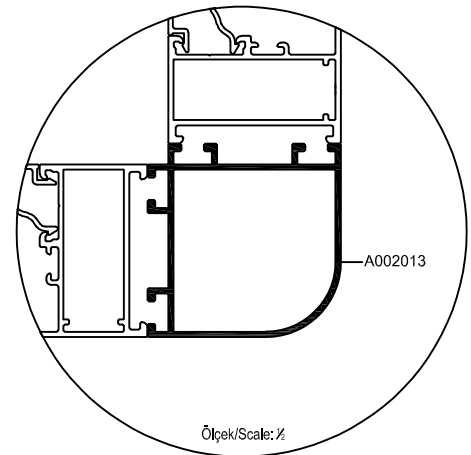
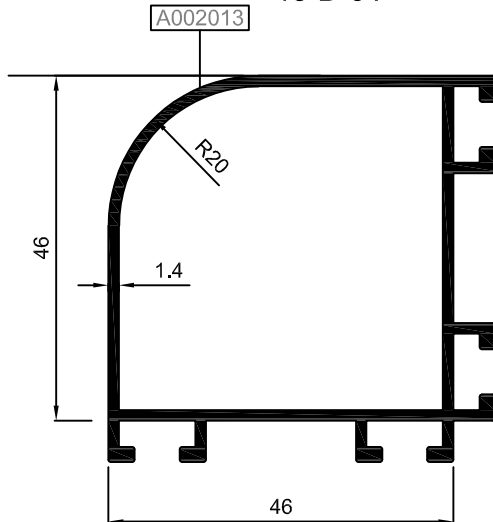

KOD/ CODE	AĞIRLIK (kg/m)/ WEIGHT	Jxx cm ⁴	Jyy cm ⁴	L m
46 D 02	0,794	----	----	6
46 A 10	0,398	----	----	6
46 A 08	0,354	----	----	6

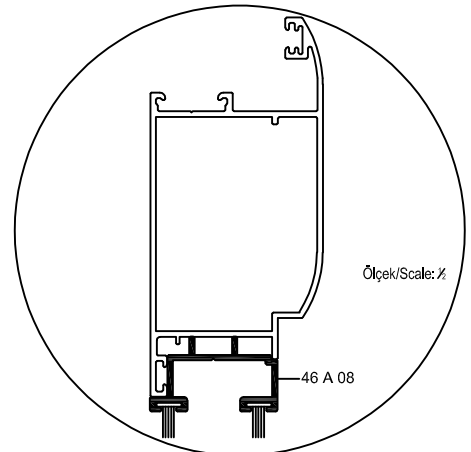
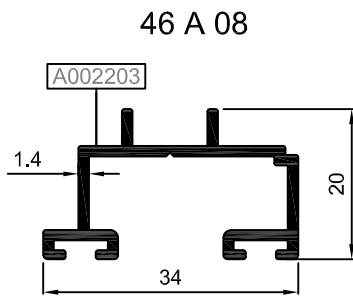
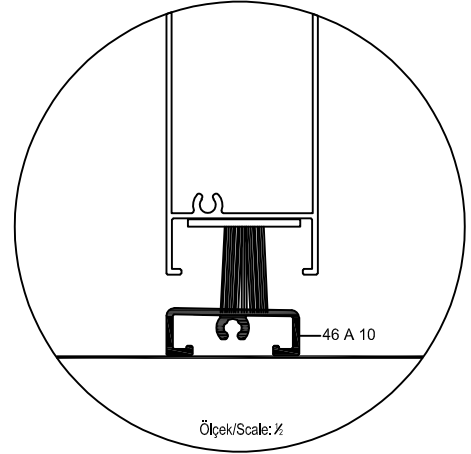
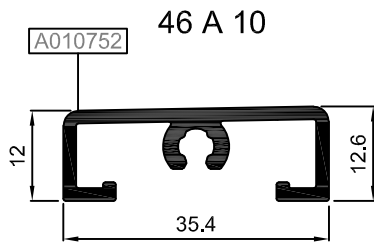
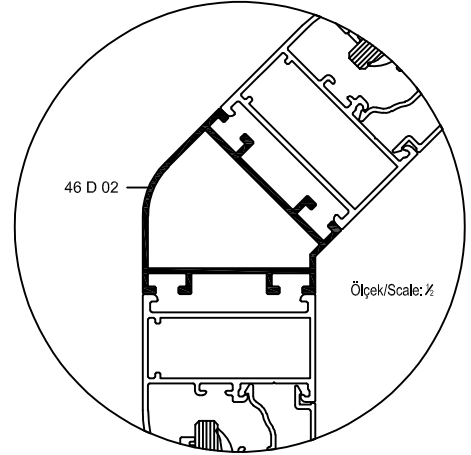
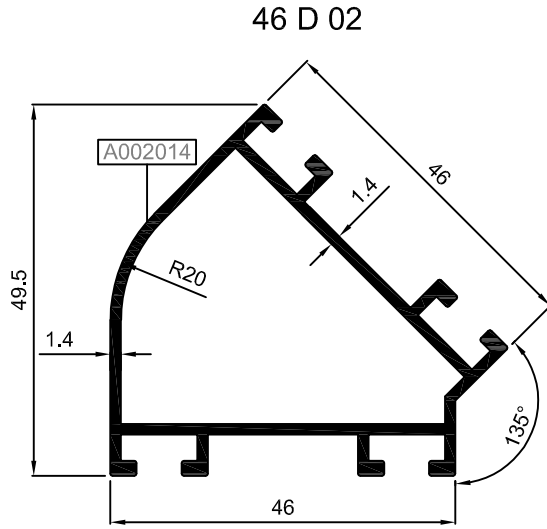
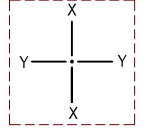

CAM ÇITA PROFİLLERİ
GLAZING BEAD PROFILES

RW46

KOD/ CODE	AĞIRLIK (kg/m)/ WEIGHT	L m	KOD/ CODE	AĞIRLIK (kg/m)/ WEIGHT	L m
25 G 21	0,196	6	25 G 12	0,270	6
25 G 37	0,206	6	25 G 13	0,278	6
25 G 11	0,224	6	25 G 14	0,280	6
25 G 10	0,225	6	25 G 15	0,282	6
25 G 09	0,229	6			

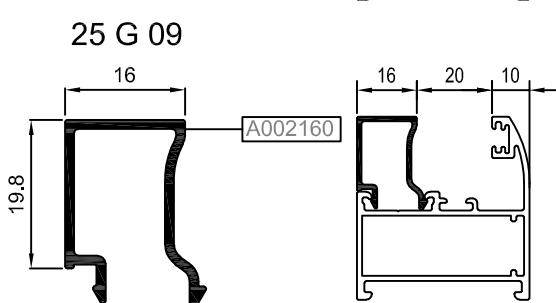
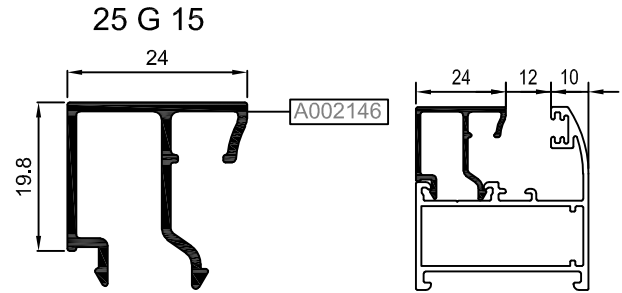
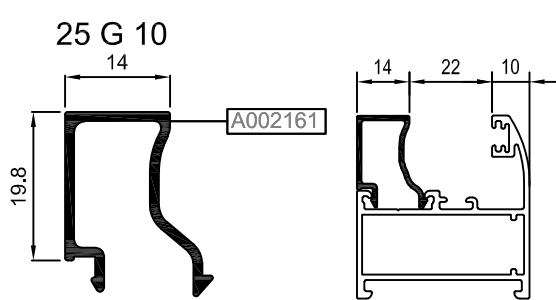
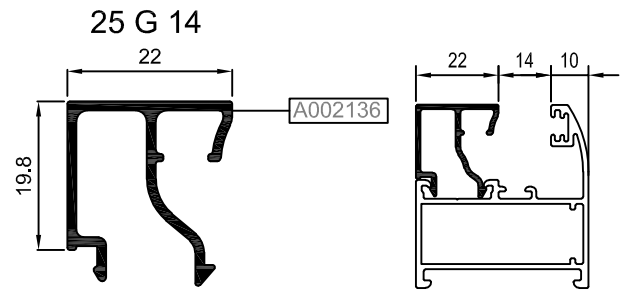
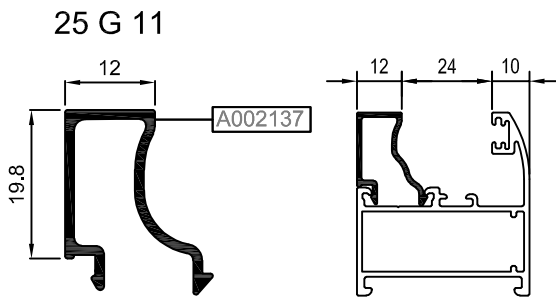
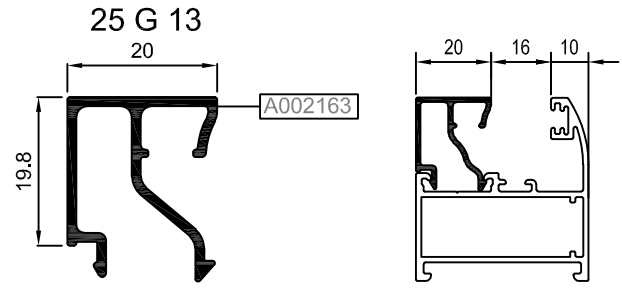
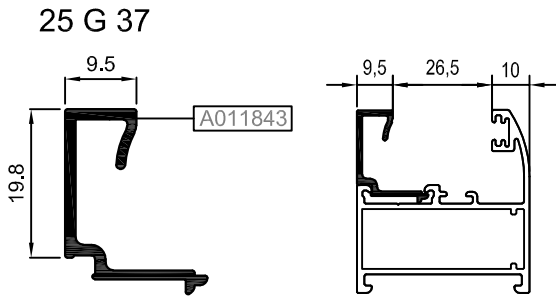
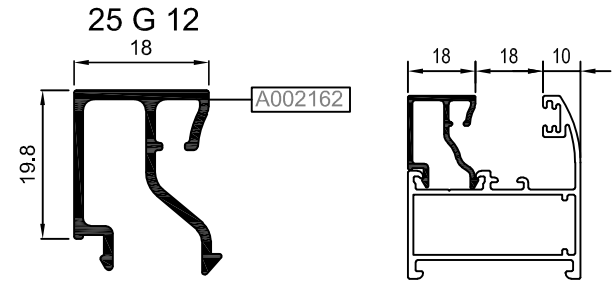
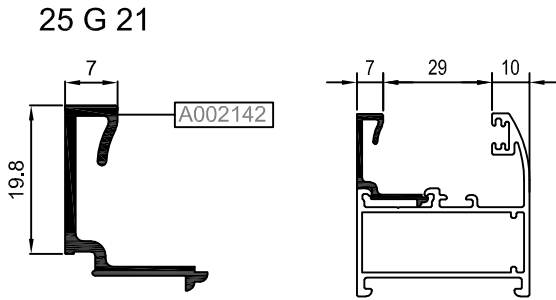
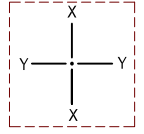

CAM TABLOSU GLASS TABLE

RW46

B, CAM ÇİTASI GLAZING BEAD	C, İÇ CAM FİTLİ GLASS GASKET (IN)	A, CAM KALINLIĞI GLASS THICKNESS	D, DIŞ CAM FİTLİ GLASS GASKET (OUT)
25 G 15	01.17.04	4 mm	01.11.15
25 G 15	01.17.03	5 mm	01.11.15
25 G 14	01.17.04	6 mm	01.11.15
25 G 14	01.17.03	7 mm	01.11.15
25 G 13	01.17.04	8 mm	01.11.15
25 G 13	01.17.03	9 mm	01.11.15
25 G 12	01.17.04	10 mm	01.11.15
25 G 12	01.17.03	11 mm	01.11.15
25 G 09	01.17.04	12 mm	01.11.15
25 G 09	01.17.03	13 mm	01.11.15
25 G 10	01.17.04	14 mm	01.11.15
25 G 10	01.17.03	15 mm	01.11.15
25 G 11	01.17.04	16 mm	01.11.15
25 G 11	01.17.03	17 mm	01.11.15
25 G 37	01.17.05	18 mm	01.11.15
25 G 37	01.17.04	19 mm	01.11.15
25 G 21	01.17.05	20 mm	01.11.15
25 G 21	01.17.04	21 mm	01.11.15
25 G 21	01.17.03	22 mm	01.11.15

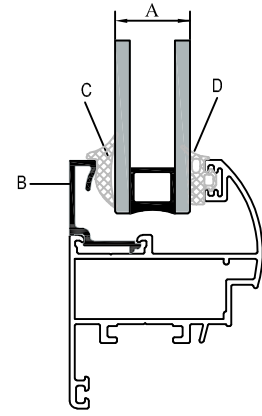
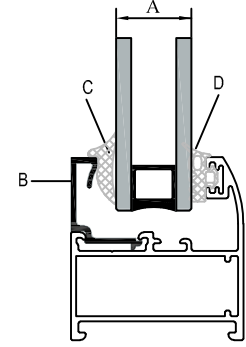

KÖŞE TAKOZLARI VE ORTA KAYIT BAĞLANTI PROFİLLERİ CORNER CLEATS AND MULLION CONNECTION PROFILES

RW46

PROFİL KODU (PROFILE CODE)	25 L 03	25 L 04	25 L 51	25 L 52	25 J 13
FABRİKA KODU (FACTORY CODE)	A002021	A002211	A010887	A010888	A010959
AĞIRLIK (WEIGHT)	4,315 kg/m	7,711 kg/m	4,409 kg/m	4,377 kg/m	0,950 kg/m
ÇİZİM (DRAWING)					

PROFİL KODU (PROFILE CODE)	25 L 14	25 L 26
FABRİKA KODU (FACTORY CODE)	A002059	A010540
AĞIRLIK (WEIGHT)	3,270 kg/m	4,870 kg/m
ÇİZİM (DRAWING)		

Nr		KESİM ÖLÇÜSÜ CUTTING SIZE	AKS. KODU ACS. CODE
R46 F 01	A010856		
R46 F 02	A010891	25 L 51 (A010887)	124 L 51
R46 F 03	A010908		
R46 F 04	A010857	25 L 52 (A010888)	122 L 52
R46 F 05	A010858	25 L 51 (A010887)	124 L 51
R46 F 06	A010859	25 L 52 (A010888)	122 L 52
R46 V 01	A010860	25 L 04 (A002211)	177 L 04
R46 V 02	A010861		
R46 V 03	A010973	25 L 04 (A002211)	122 L 04
R46 V 04	A010960	25 L 03 (A002021)	113 L 03
R46 V 05	A011776	25 L 26 (A010540)	144 L 26
R46 V 06	A011777	25 L 14 (A002059)	144 L 14
R46 V 07			
Nr		KESİM ÖLÇÜSÜ CUTTING SIZE	AKS. KODU ACS. CODE
R46 M 03	A010960	25 J 13 (A010959)	307 J 13

STOKTA BULUNAN SİSTEM PROFİLLERİNİN LİSTESİ (LIST OF SYSTEM PROFILES IN STOCK)

Nr	MIN. SİPARİŞ MİKTARI MIN. ORDER QUANTITY
R46 F 02	A010857 75 kg
R46 M 01	A010862 75 kg
R46 K 01	A010866 75 kg

* STOKTA BULUNMAYAN TÜM PROFİLLER İÇİN MİNİMUM SİPARİŞ MİKTARI 300 KG'DIR.
MINIMUM ORDER QUANTITY FOR ALL THE PROFILES THAT ARE NOT IN STOCK IS 300 KG.

MİMARİ KATALOG

ARCHITECTURAL CATALOGUE

Alüminyum Kapı Pencere ve Giydirme Cephe Sistemleri
Aluminium Window Doors and Facade Systems



Rescara Sistem Detayları
Rescara System Details

RW46

DETAYLAR

DETAILS

01

02

03

04

05

06

07

08

09

10

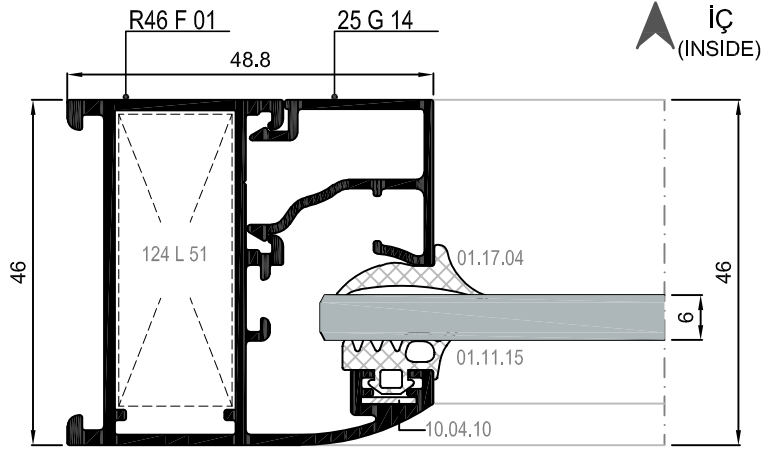
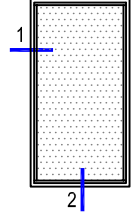

① DETAYI
DETAIL

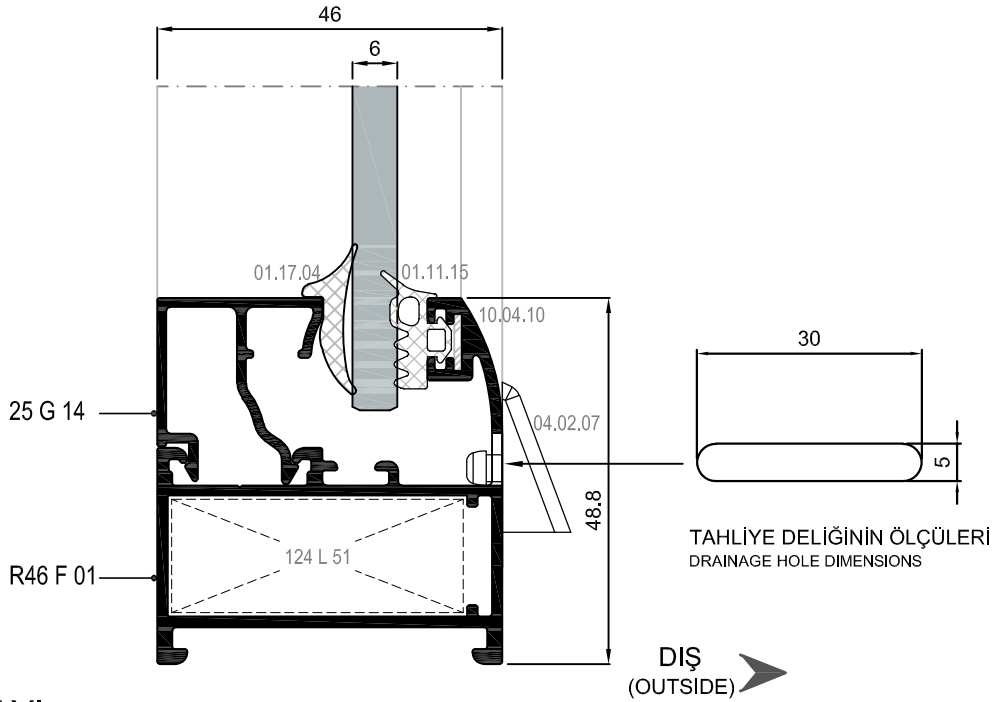

② DETAYI
DETAIL

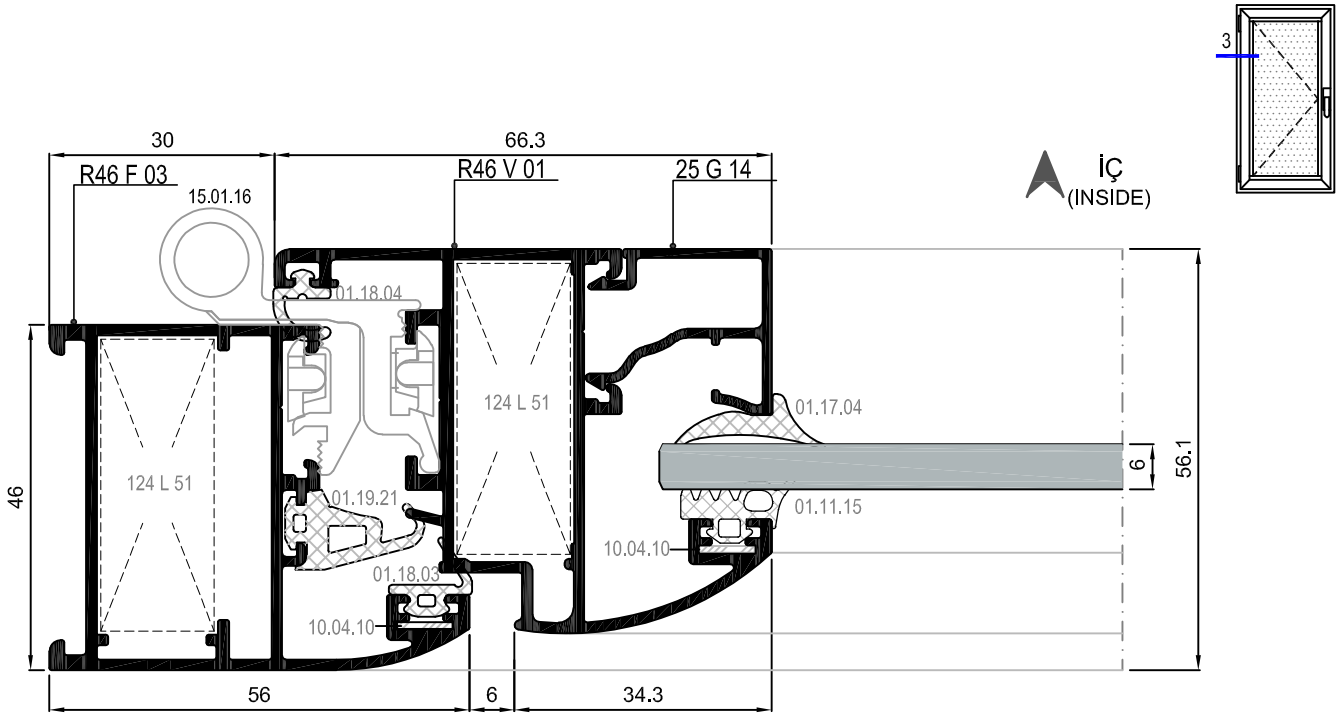

③ DETAYI
DETAIL

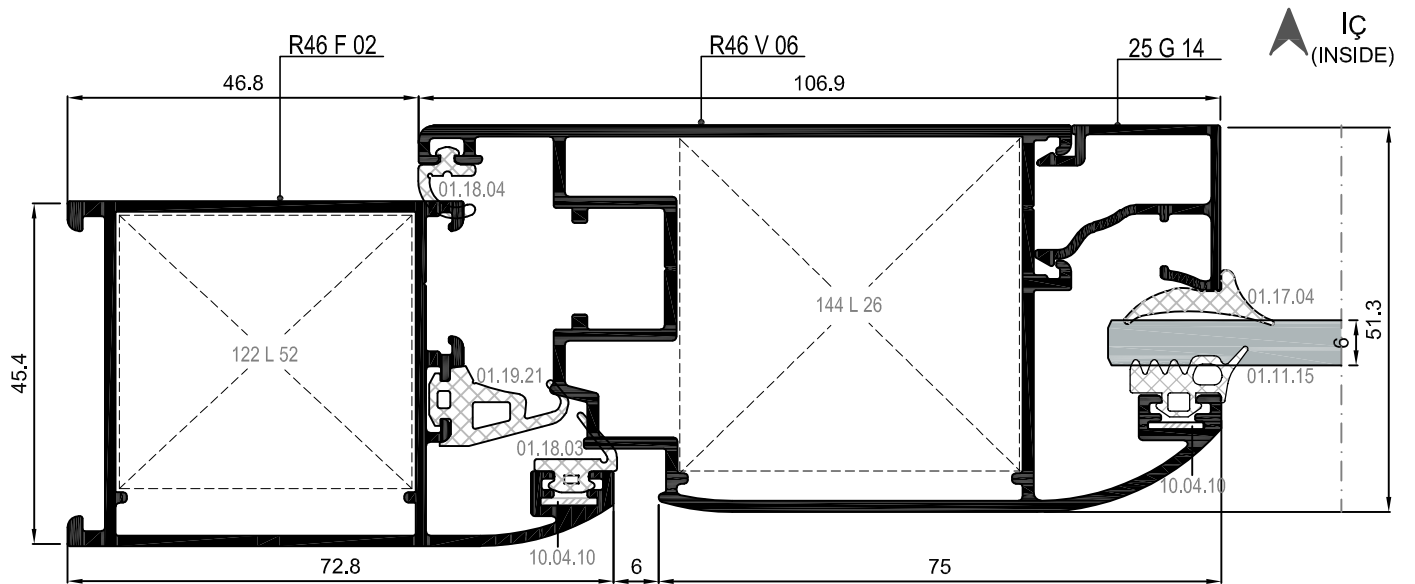

PVC AÇILIM AKSESUARINA UYGUN KANAT DETAYI
VENT DETAIL FOR PVC OPENING ACCESSORIES

③A DETAYI
DETAIL

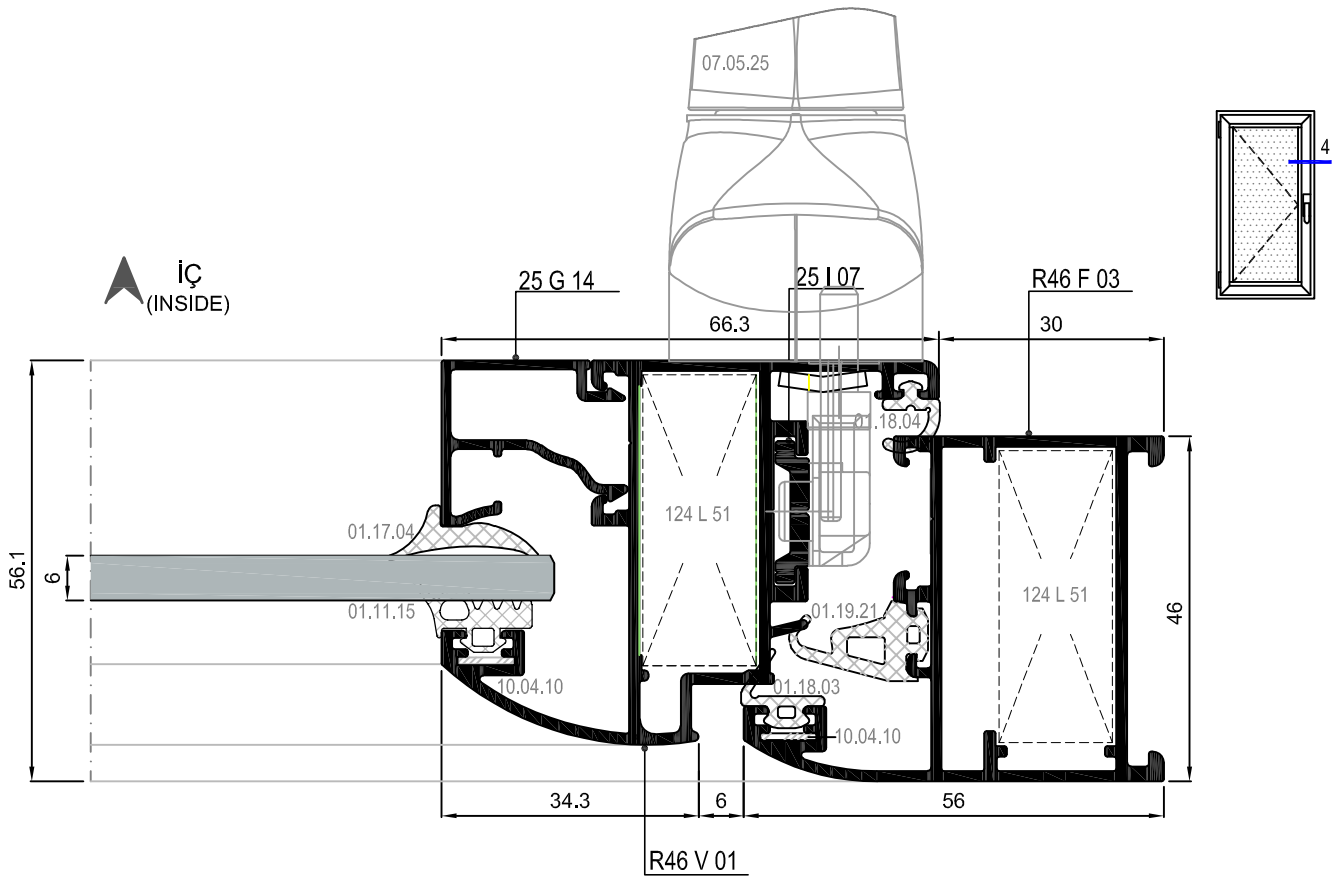

④ DETAYI
DETAIL

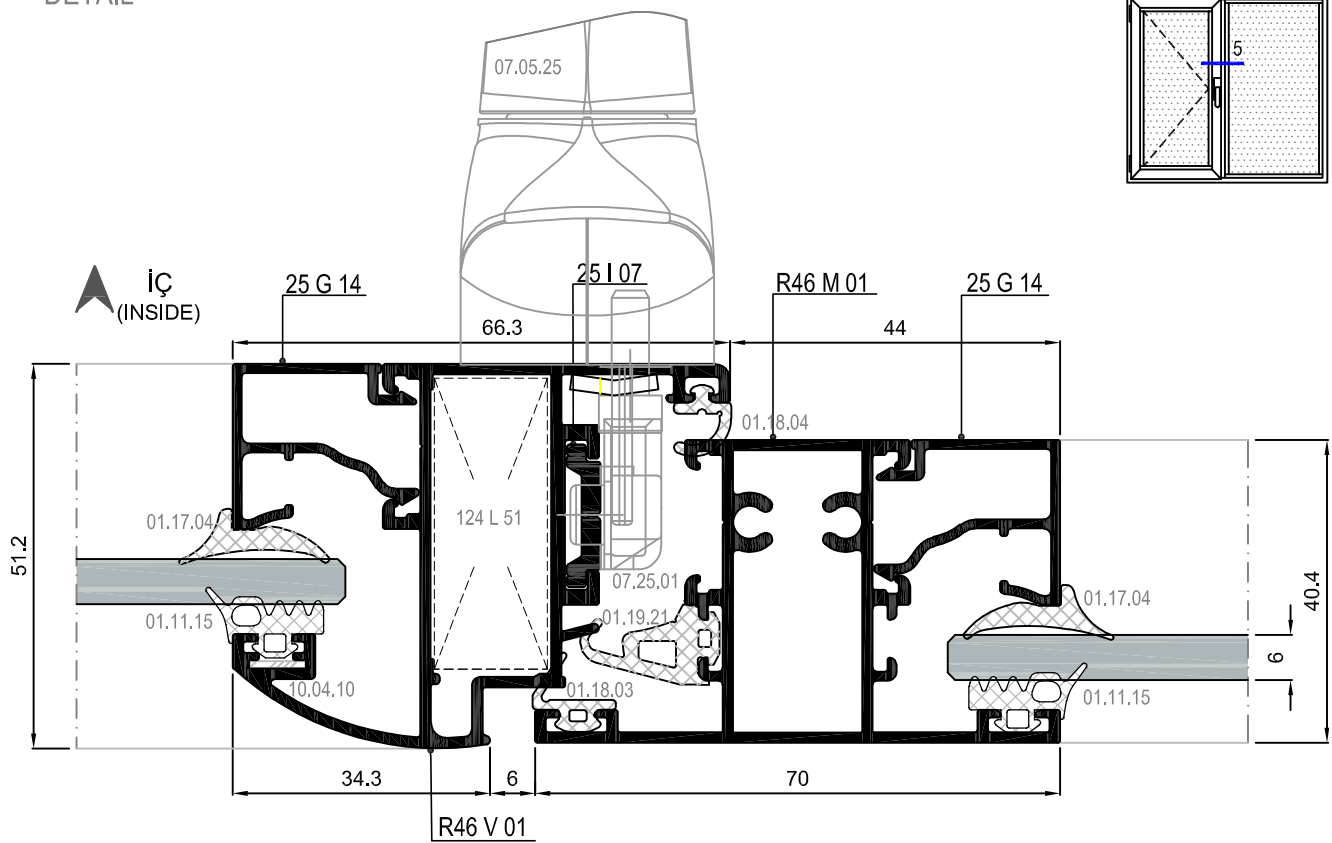

⑤ DETAYI
DETAIL

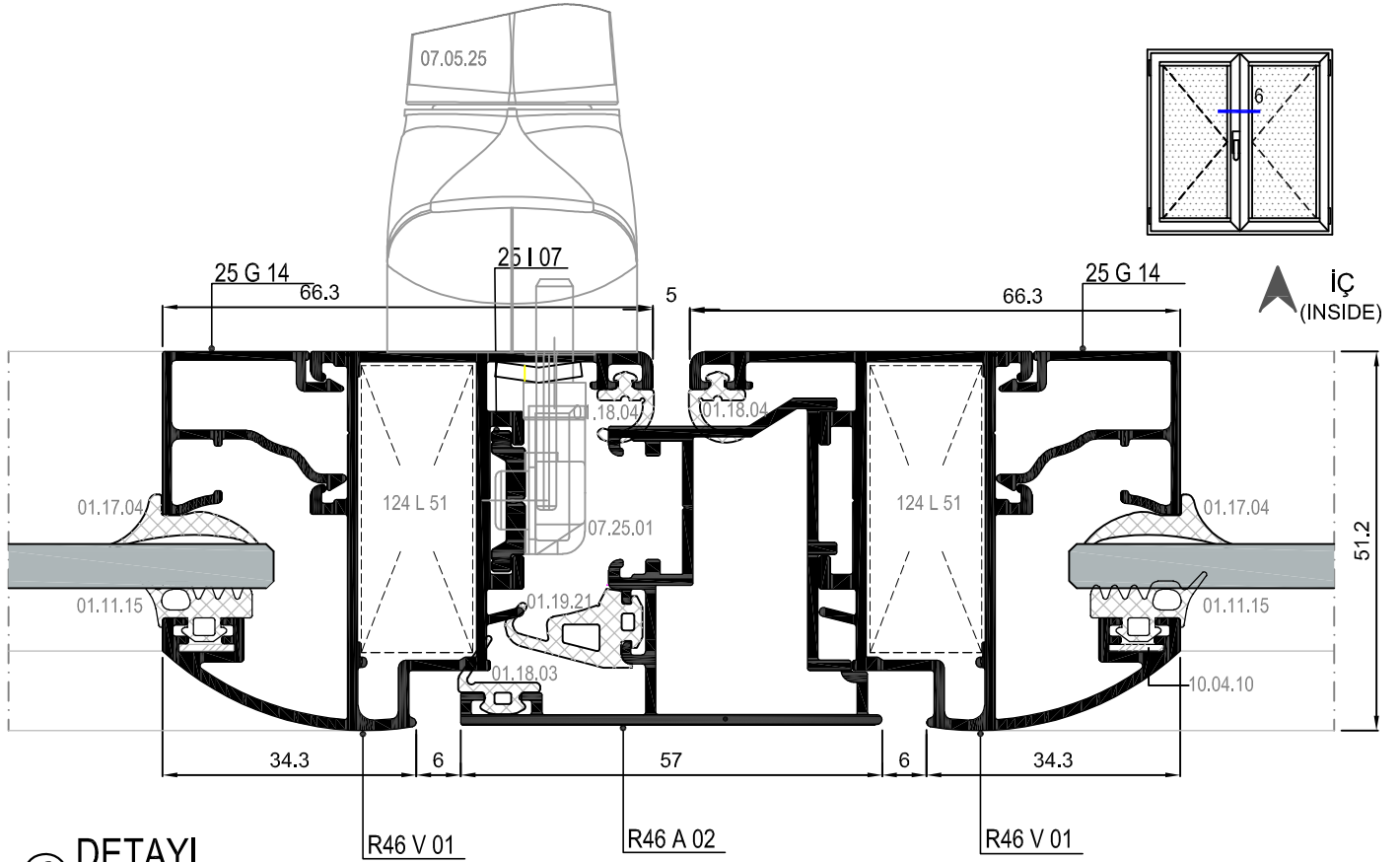

⑥ DETAYI
DETAIL

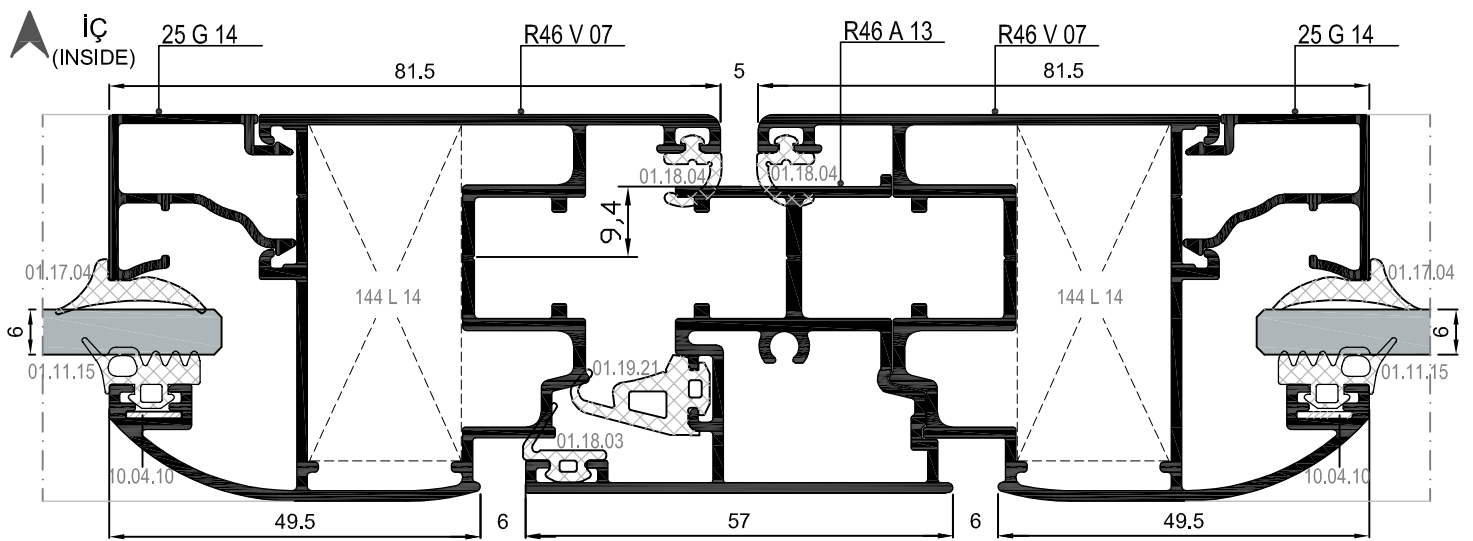

PVC AÇILIM AKSESUARINA UYGUN KANAT DETAYI
VENT DETAIL FOR PVC OPENING ACCESSORIES

⑥A DETAYI
DETAIL

İÇE AÇILIM BİNLİLİ KAPI DETAYLARI
INWARD OPENING DOOR DETAILS

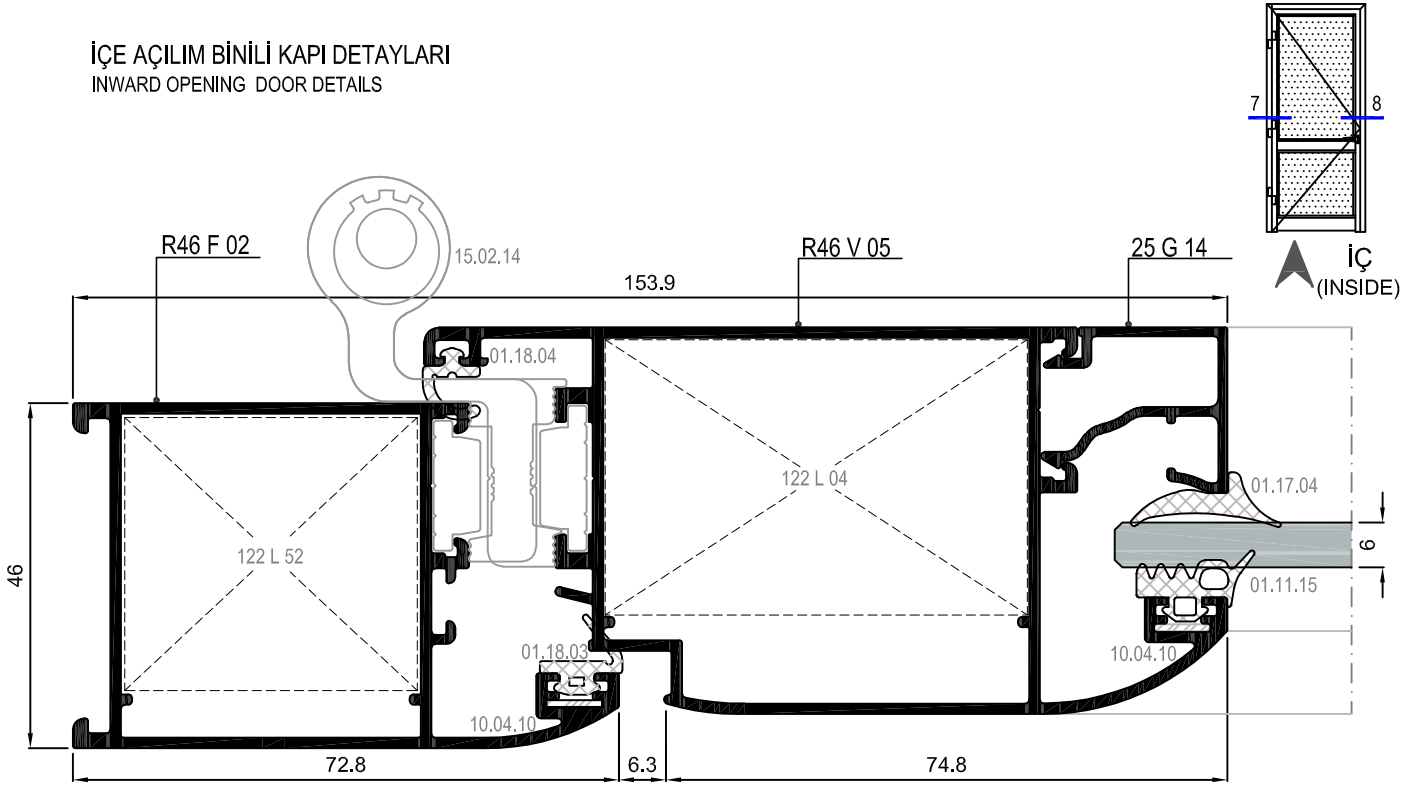

⑦ DETAYI
DETAIL

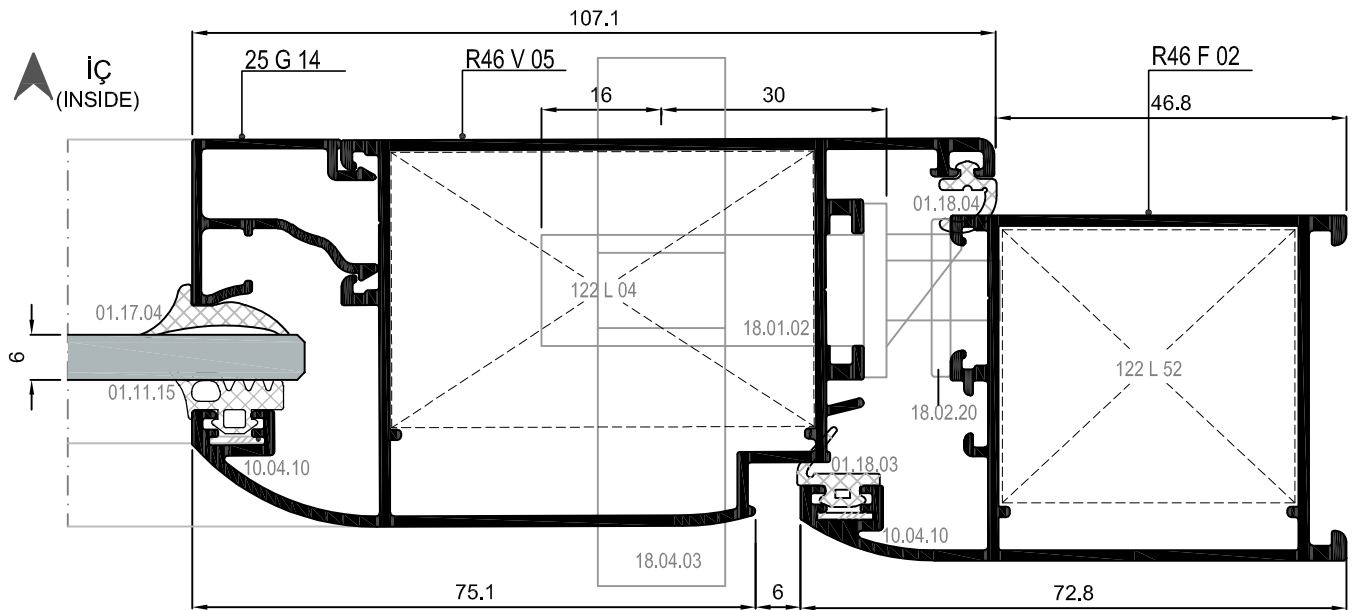

⑧ DETAYI
DETAIL

DETAYLAR
DETAILS

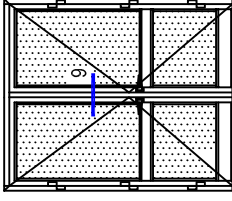

İÇE AÇILIM BİNLİ KAPI DETAYLARI
INWARD OPENING DOOR DETAILS

RW46

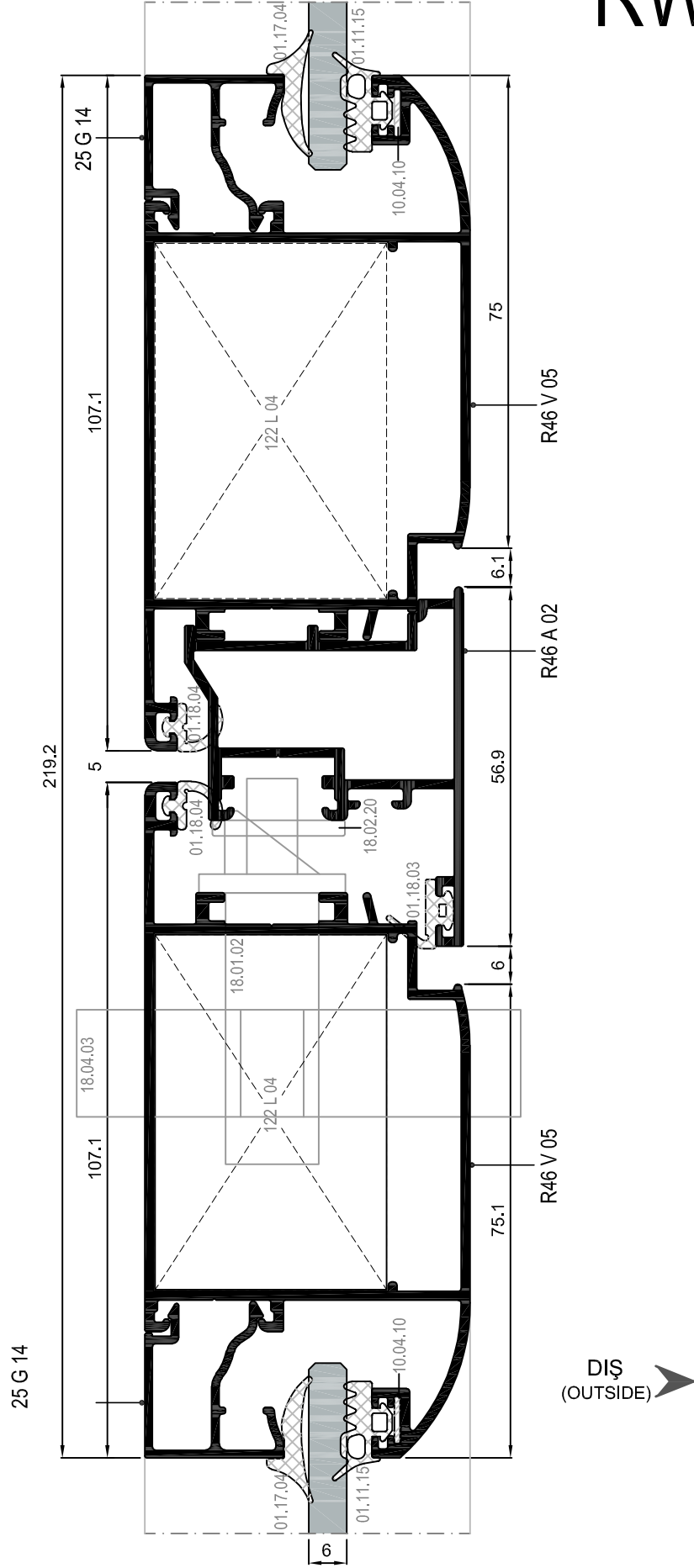

İÇE AÇILIM HEMYÜZ KAPI DETAYLARI
INWARD OPENING FLUSH DOOR DETAILS

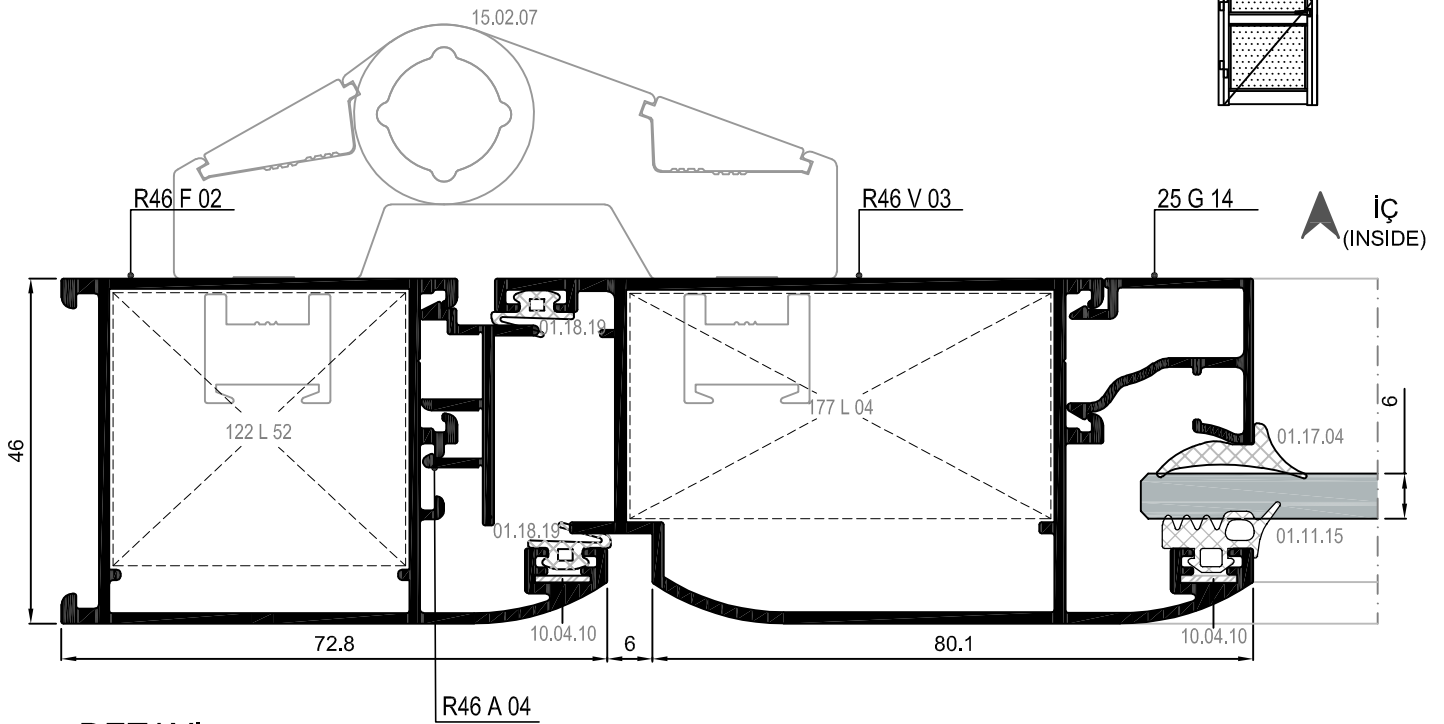
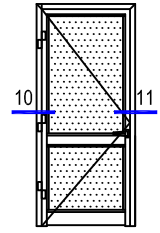

⑩ DETAYI
DETAIL

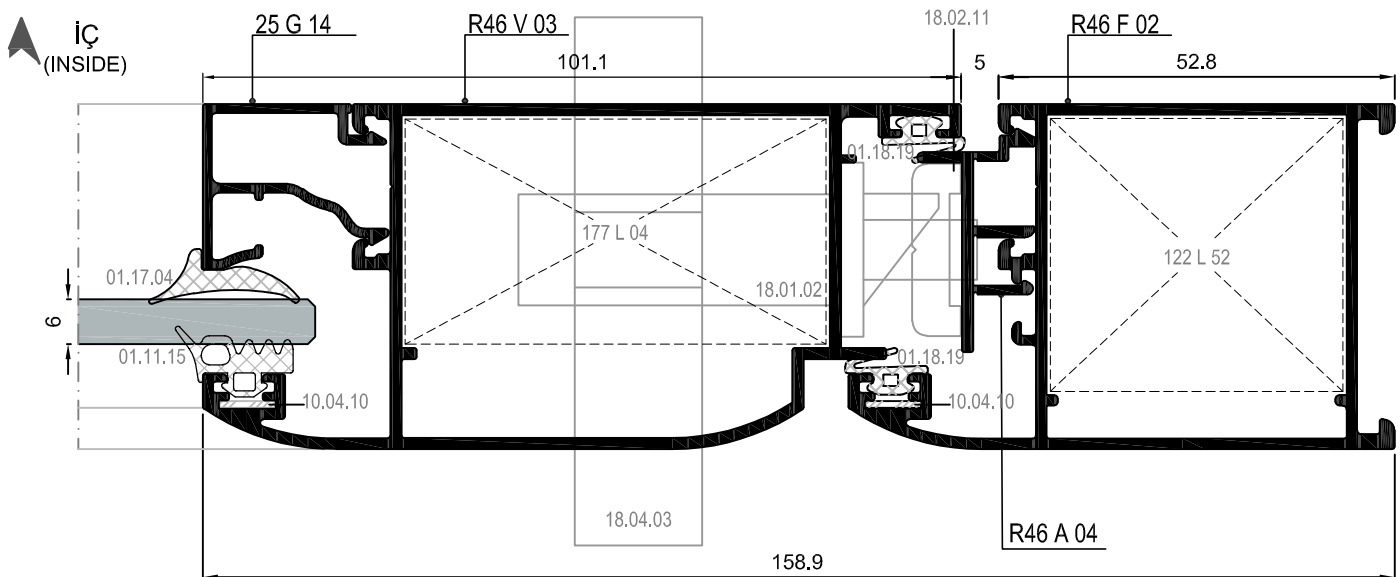

⑪ DETAYI
DETAIL

DIŐA AÇILIM HEMYÜZ KAPI DETAYLARI
OUTWARD OPENING FLUSH DOOR DETAILS

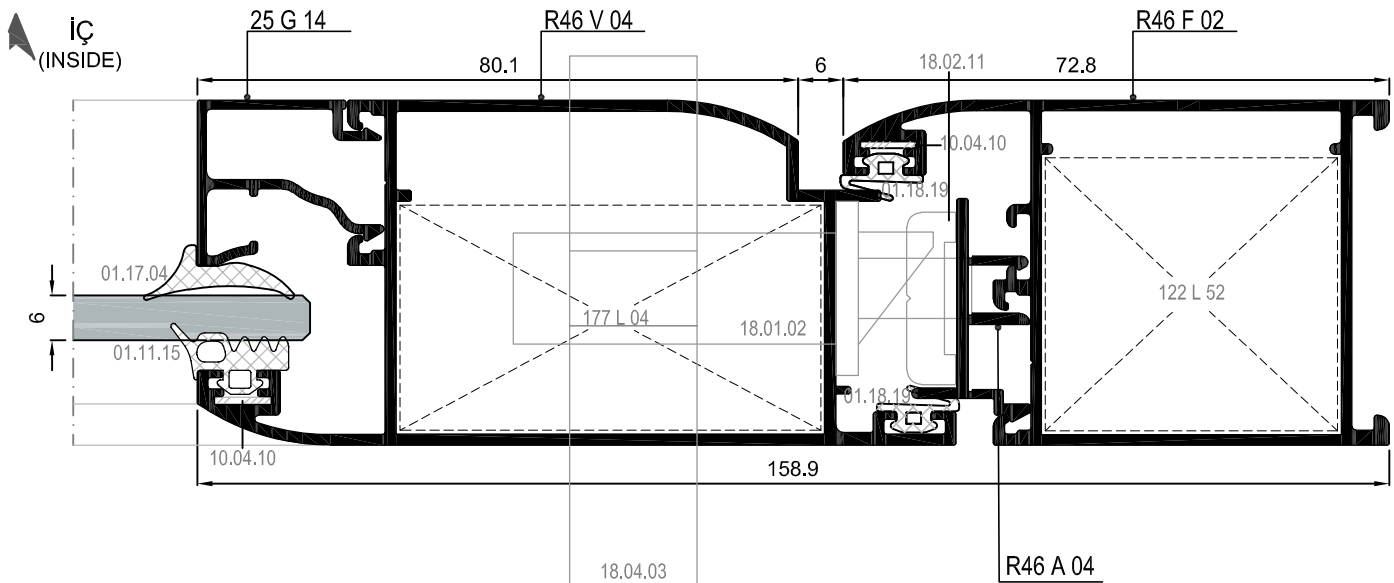
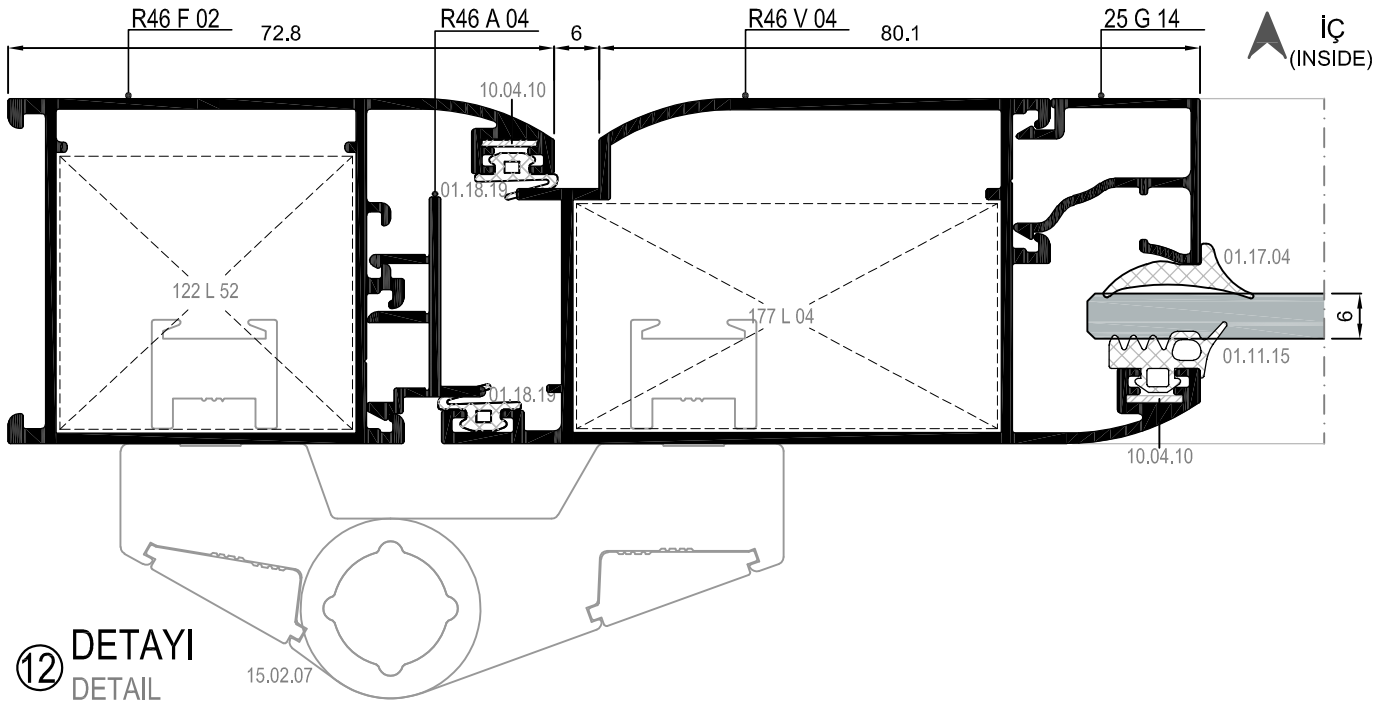
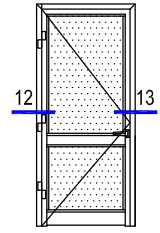

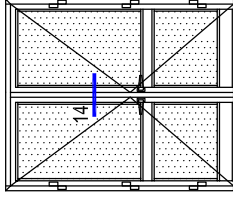

DIŐA AÇILIM HEMYÜZ KAPI DETAYLARI
OUTWARD OPENING FLUSH DOOR DETAILS

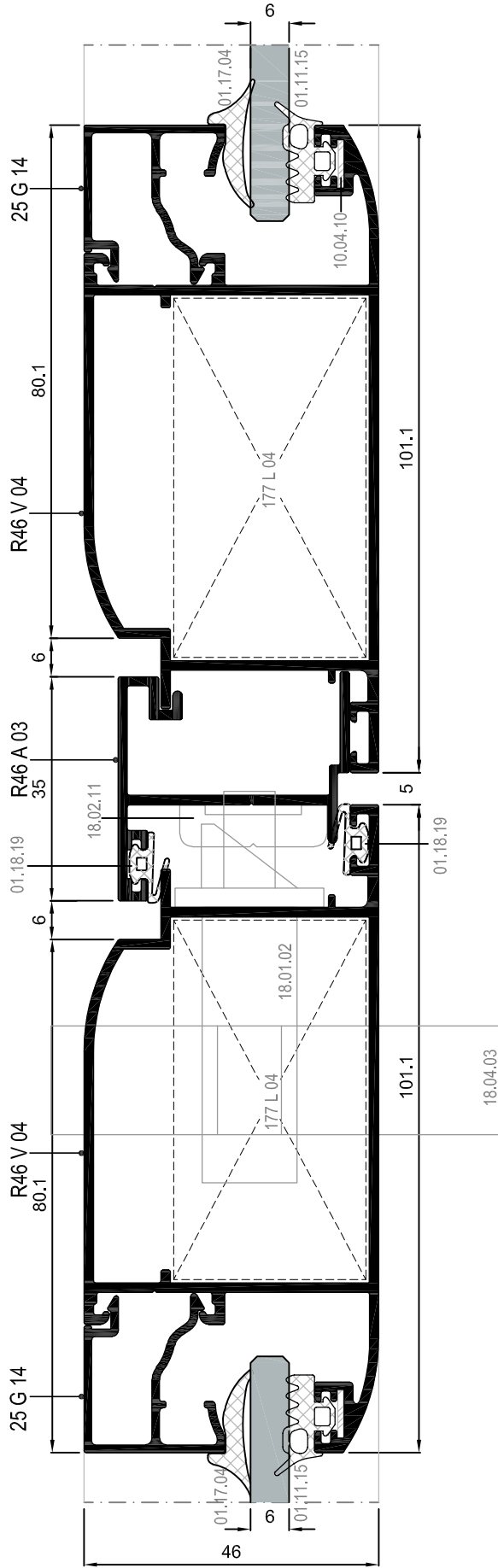

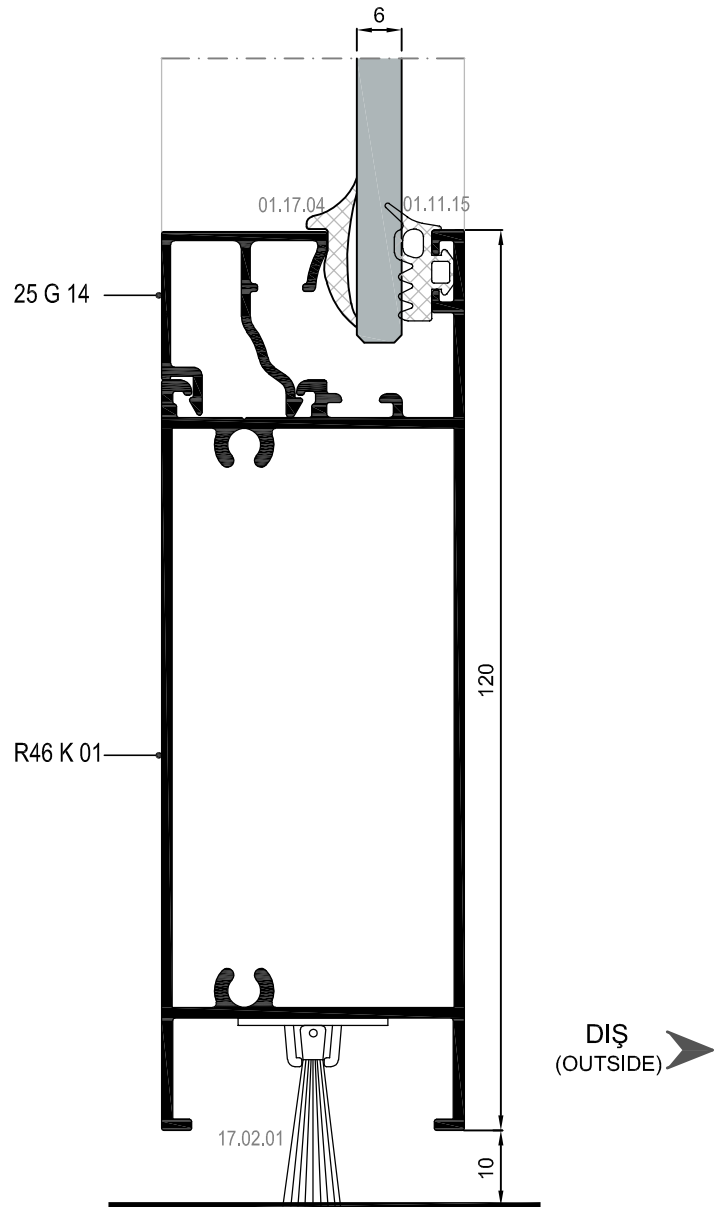
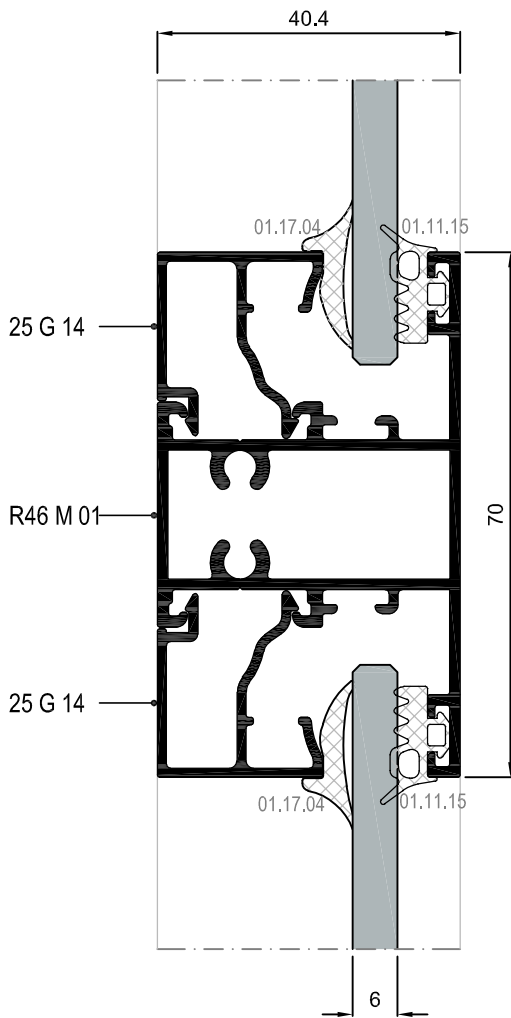
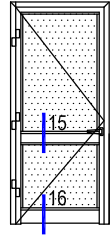

15 DETAYI
DETAIL

16 DETAYI
DETAIL

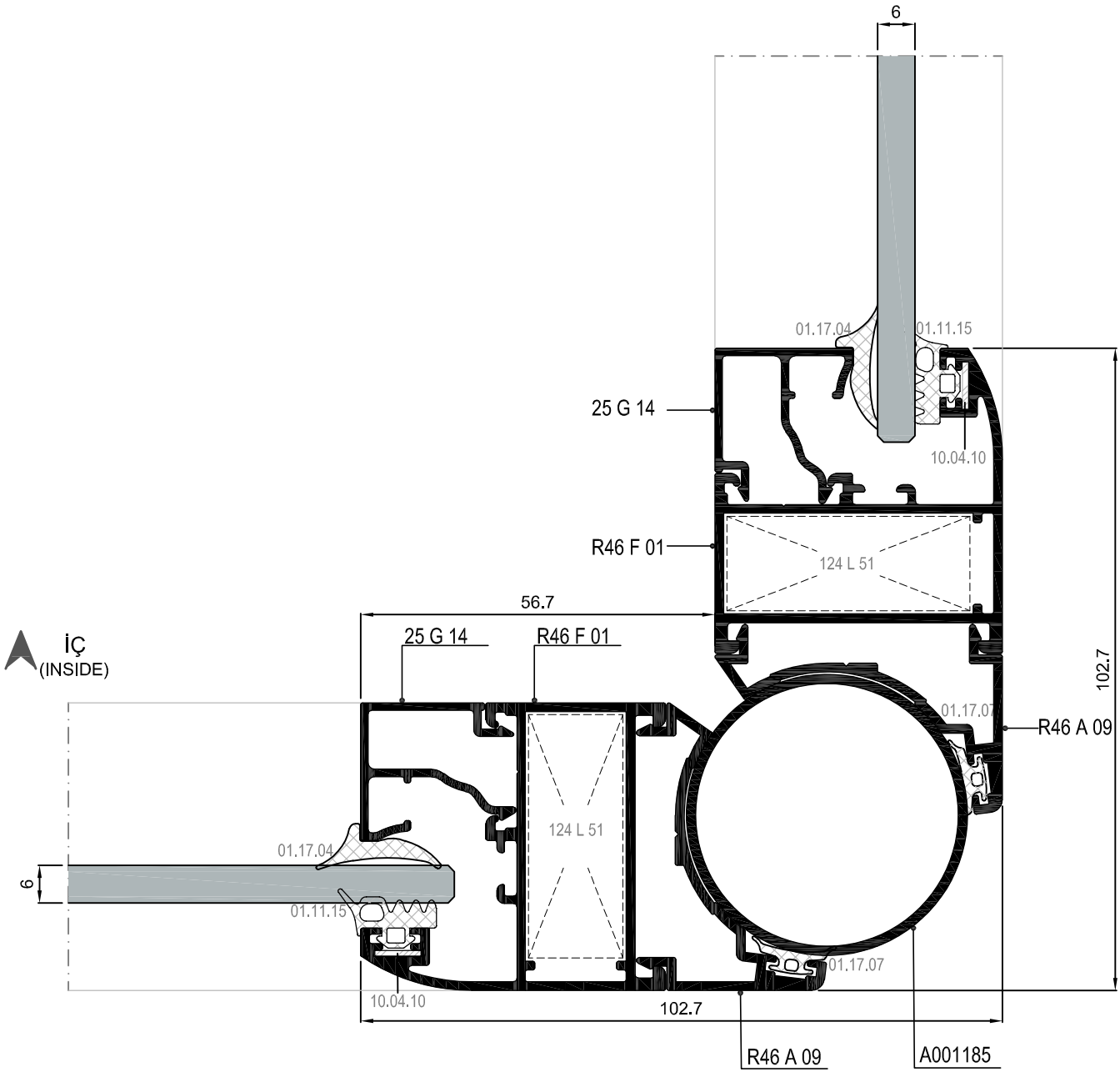
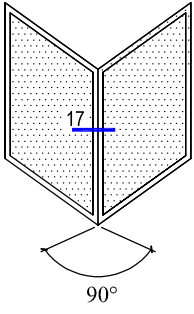

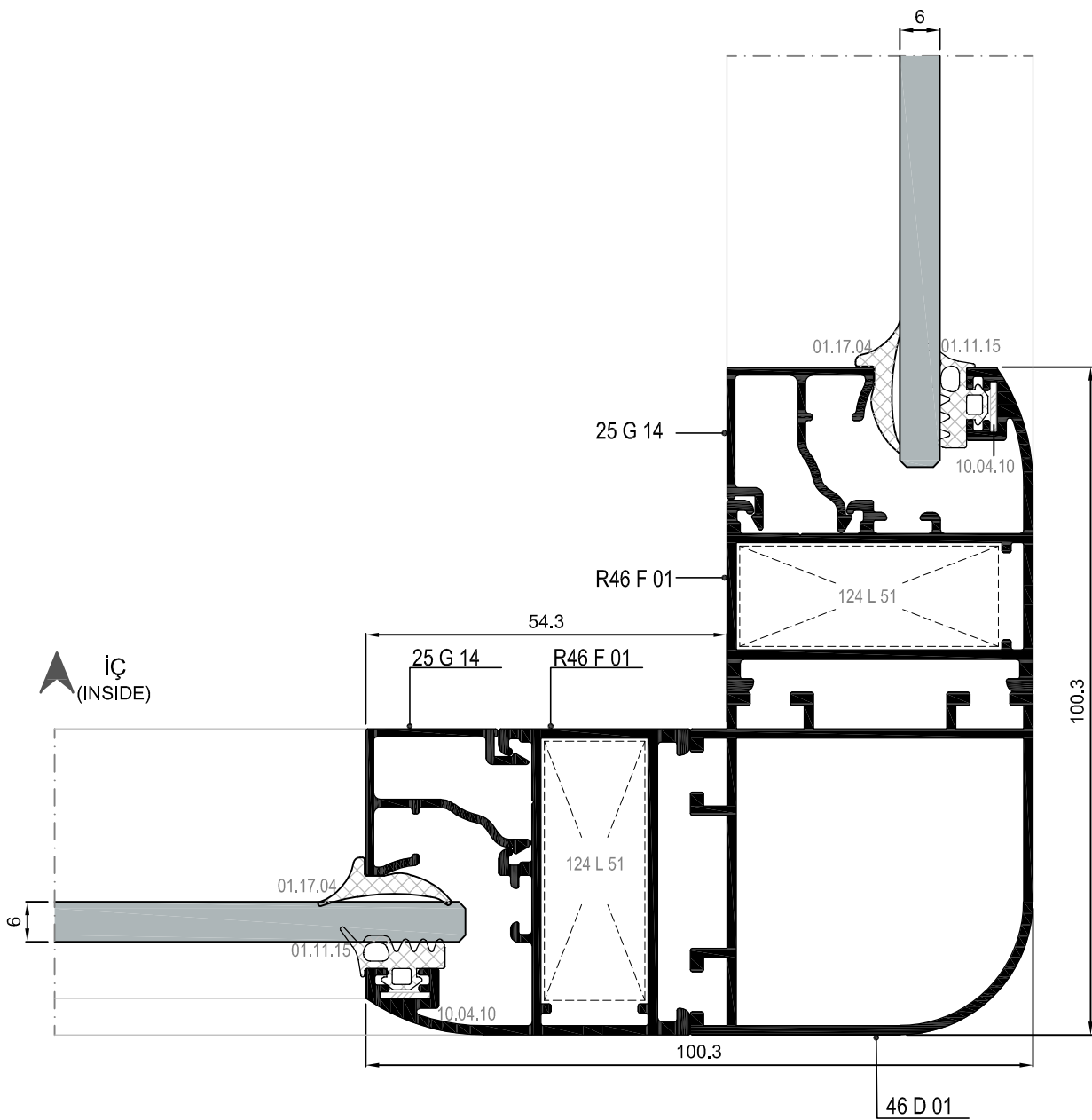
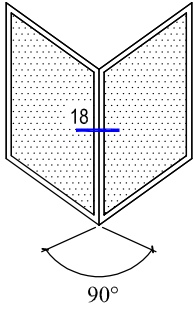

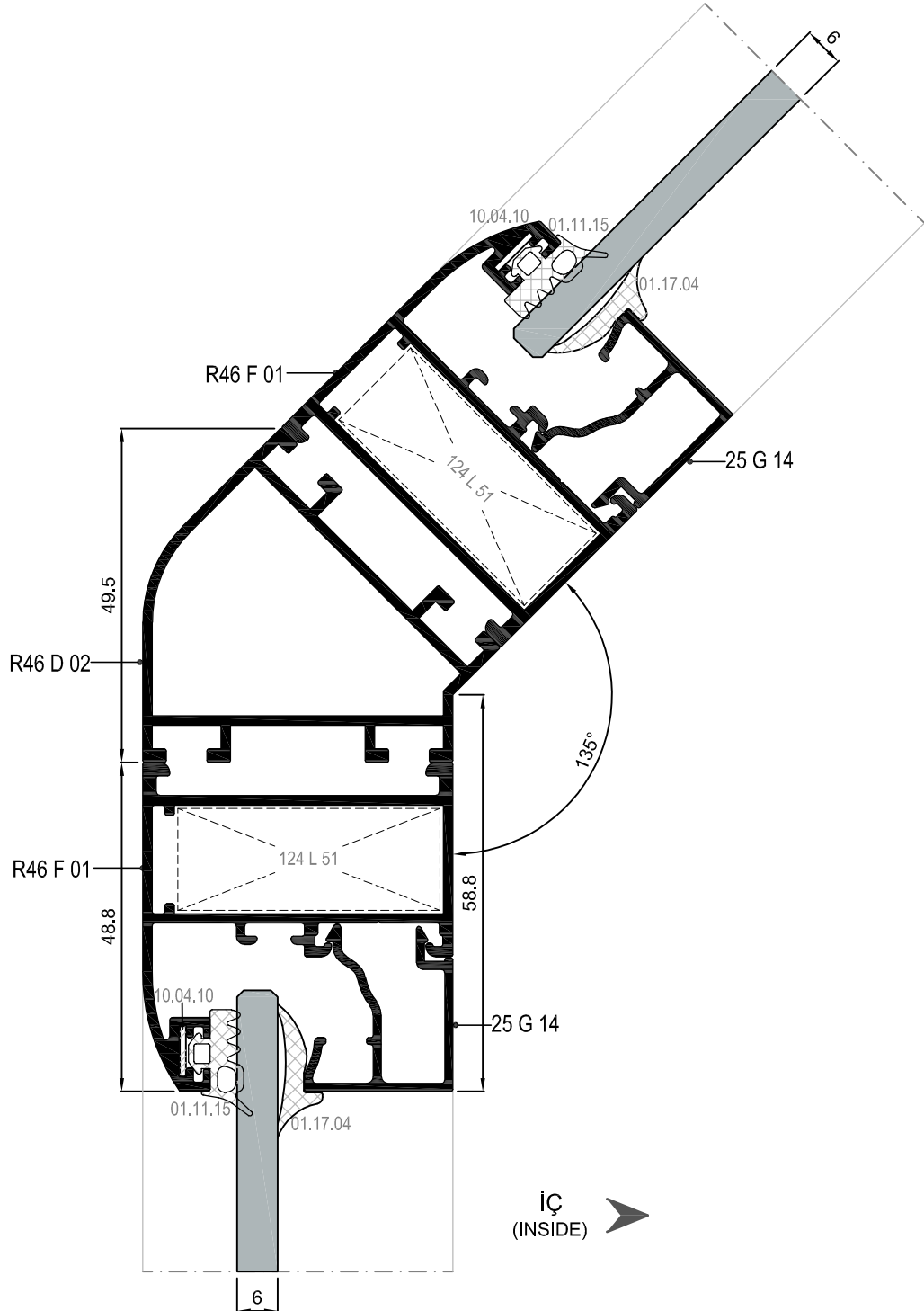
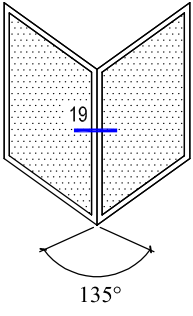

MİMARİ KATALOG

ARCHITECTURAL CATALOGUE

Alüminyum Kapı Pencere ve Giydirme Cephe Sistemleri
Aluminium Window Doors and Facade Systems



Rescara Sistem Detayları
Rescara System Details

RW46

AKSESUARLAR

ACCESSORIES

01

02

03

04

05











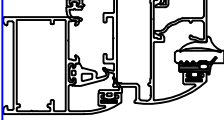



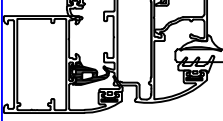

06

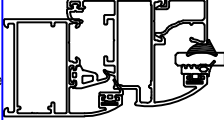
07

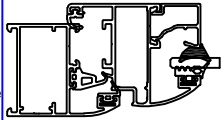
08

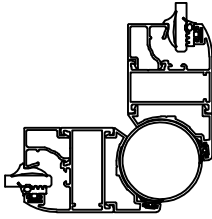
09

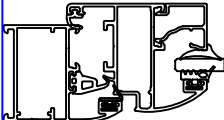
10

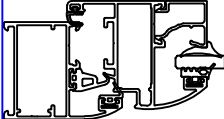
	01.11.15 DIŞ CAM FITİLİ 4 mm OUTSIDE GLAZING GASKET 4 mm Malzeme / Material : EPDM Ağırlık / Weight : 78 gr/m Paket / Package: 190m / 15 kg			01.19.06 ÇITA KANAL FITİLİ ADAPTER GASKET Malzeme / Material : EPDM Ağırlık / Weight : 80 gr/m Paket / Package: 185m / 15 kg	
	01.17.03 İÇ CAM FITİLİ 3 mm boşluk için INSIDE GLAZING GASKET for 3 mm space Malzeme / Material : EPDM Ağırlık / Weight : 59 gr/m Paket / Package: 254 m / 15 kg			01.19.21 TOZLUK FITİLİ CENTRAL GASKET Malzeme / Material : EPDM Ağırlık / Weight : 120 gr/m Paket / Package: 125m / 15 kg	
	01.17.04 İÇ CAM FITİLİ 4 mm boşluk için INSIDE GLAZING GASKET for 4 mm space Malzeme / Material : EPDM Ağırlık / Weight : 69 gr/m Paket / Package: 215m / 15 kg				
	01.17.05 İÇ CAM FITİLİ 5 mm boşluk için INSIDE GLAZING GASKET for 5 mm space Malzeme / Material : EPDM Ağırlık / Weight : 89 gr/m Paket / Package: 168 m / 15 kg				
	01.17.07 DIŞ BİNİ FITİLİ OUTSIDE ACOUSTICAL GASKET Malzeme / Material : EPDM Ağırlık / Weight : 38 gr/m Paket / Package: 400m / 15 kg				
	01.18.03 DIŞ BİNİ FITİLİ OUTSIDE ACOUSTICAL GASKET Malzeme / Material : EPDM Ağırlık / Weight : 41 gr/m Paket / Package: 365m / 15 kg				
	01.18.04 İÇ BİNİ FITİLİ INSIDE ACOUSTICAL GASKET Malzeme / Material : EPDM Ağırlık / Weight : 42 gr/m Paket / Package: 357m / 15 kg				

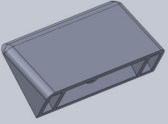
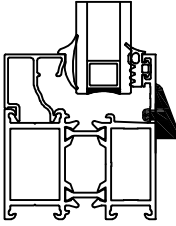
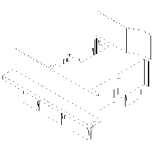
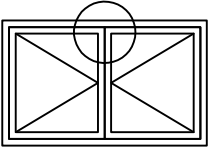
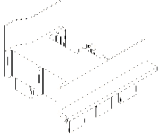
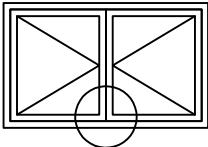
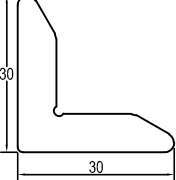
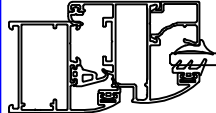
	<p>04.02.07</p> <p>TAHLİYE KAPAĞI DRAINAGE COVER</p> <p>Malzeme / Material : PVC Renk / Colour : Siyah-Beyaz-Gri Black-White-Grey</p>				
	<p>04.06.34</p> <p>ADAPTÖR KAPAĞI ADAPTER CAP</p> <p>Malzeme / Material : PVC Renk / Colour : Siyah / Black R46A02 İÇİN / FOR R46A02</p>				
	<p>04.06.35</p> <p>ADAPTÖR KAPAĞI ADAPTER CAP</p> <p>Malzeme / Material : PVC Renk / Colour : Siyah / Black R46A02 İÇİN / FOR R46A02</p>	 <p>USE WITH: R46 A 02</p>			
	<p>10.04.10</p> <p>KÖŞE ÇAVUŞU CORNER PIECE</p> <p>Malzeme / Material : Paslanmaz çelik/ Stainless steel</p>				

PENCERE MENTEŞELERİ / WINDOW HINGES



15.01.16

GIESSE PENCERE MENTEŞESİ
GIESSE HINGE FOR WINDOWS

Renk / Colour : Siyah-Beyaz-Gri-Eloksal
Black-White-Grey-Anodised

75 kg için 2 adet, 85 kg için 3 adet kullanılmalıdır. / Should be used 2 for 75 kg,3 for 85 kg.
EN 1935:2002



15.01.03

RESCARA PENCERE MENTEŞESİ
HINGE FOR WINDOWS

Renk / Colour : Pres-Eloksal
Press-Anodised

75 kg için 2 adet, 85 kg için 3 adet kullanılmalıdır. / Should be used 2 for 75 kg,3 for 85 kg.
EN 1935:2002

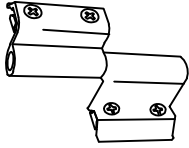

15.01.08

YERLİ PENCERE MENTEŞESİ
LOCAL HINGE FOR WINDOWS

Renk / Colour : Siyah-Beyaz-Gri-Eloksal
Black-White-Grey-Anodised

50 kg için 2 adet kullanılmalıdır. / Should be used 2 for 50 kg.
Max. kanat ölçüsü 900x1300 / Max. vent dimension 900x1300
TS EN 1935

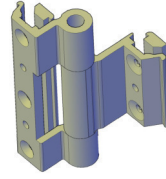

15.01.12

YERLİ PENCERE MENTEŞESİ
LOCAL HINGE FOR WINDOWS

Renk / Colour : Siyah-Beyaz-Gri-Eloksal
Black-White-Grey-Anodised

TS EN 1935



15.01.17

GIESSE GİZLİ PENCERE MENTEŞESİ (SAĞ)
GIESSE HIDDEN HINGE FOR WINDOWS (RIGHT)

Malzeme / Material :
Paslanmaz Çelik / Stainless Steel

100 kg için 2 adet kullanılmalıdır. / Should be used 2 for 100 kg.



15.01.18

GIESSE GİZLİ PENCERE MENTEŞESİ (SOL)
GIESSE HIDDEN HINGE FOR WINDOWS (LEFT)

Malzeme / Material :
Paslanmaz Çelik / Stainless Steel

100 kg için 2 adet kullanılmalıdır. / Should be used 2 for 100 kg.

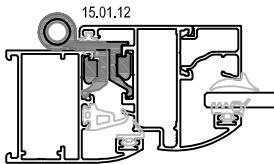
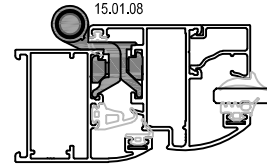
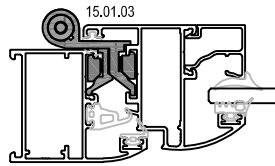
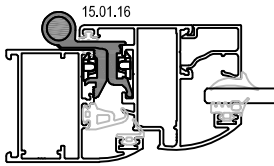

KAPI MENTEŞELERİ / DOOR HINGES



15.02.14

GIESSE KAPI MENTEŞESİ
GIESSE HINGE FOR DOORS

Renk / Colour : Siyah-Beyaz-Eloksal
Black-White-Anodized

100 kg için 2 adet, 120 kg için 3 adet kullanılmalıdır. / Should be used 2 for 100 kg, 3 for 120 kg.
EN 1935



15.02.09

YERLİ KAPI MENTEŞESİ
LOCAL HINGE FOR DOORS

Renk / Colour : Siyah-Beyaz-Grİ-Eloksal
Black-White-Grey-Anodized

85 kg için 3 adet kullanılmalıdır. / Should be used 3 for 85 kg.
Max. kanat ölçüsü 900x2200 / Max. vent dimension 900x2200
TS EN 1935

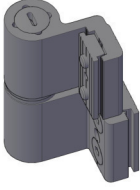

15.02.12

YERLİ KAPI MENTEŞESİ
LOCAL HINGE FOR DOORS

Renk / Colour : Siyah-Beyaz-Grİ-Eloksal
Black-White-Grey-Anodized

100 kg için 3 adet kullanılmalıdır. / Should be used 3 for 100 kg.
Max. kanat ölçüsü 900x2300 / Max. vent dimension 900x2300
TS EN 1935

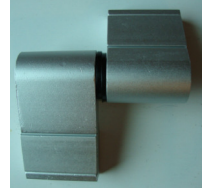

15.02.07

YERLİ KAPI MENTEŞESİ
LOCAL HINGE FOR DOORS

Renk / Colour : Siyah-Beyaz-Grİ-Eloksal
Black-White-Grey-Anodized

100 kg için 2 adet kullanılmalıdır. / Should be used 2 for 100 kg.
Max. kanat ölçüsü 900x2200 / Max. vent dimension 900x2200
TS EN 1935



15.02.20

RESCARA KAPI MENTEŞESİ
RESCARA HINGE FOR DOORS

Renk / Colour : Siyah-Beyaz-Grİ-Press-Eloksal
Black-White-Grey-Press-Anodized

120 kg için 2 adet kullanılmalıdır. / Should be used 2 for 120 kg.
EN 1935



15.02.21

RESCARA KAPI MENTEŞESİ
RESCARA HINGE FOR DOORS

Renk / Colour : Siyah-Beyaz-Grİ-Press-Eloksal
Black-White-Grey-Press-Anodized

160 kg için 2 adet kullanılmalıdır. / Should be used 2 for 160 kg.
EN 1935

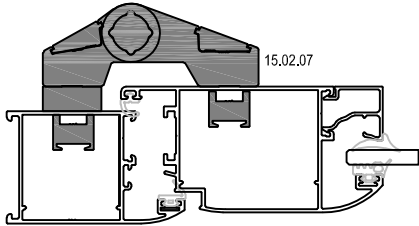

15.02.07

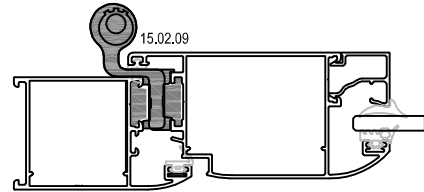

15.02.09

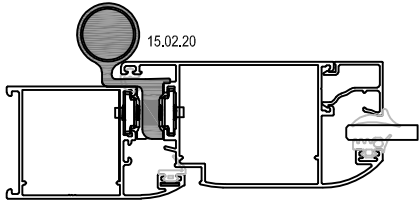

15.02.20

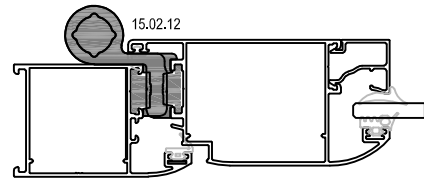

15.02.12

ÇİFT EKSEN MEKANİZMALARI / TILT & TURN MECHANISMS



GIESSE FUTURA ÇİFT AÇILIM SETİ 80 kg
GIESSE FUTURA TILT & TURN MECHANISM 80 kg

Renk / Colour : Siyah-Beyaz-Gri
Black-White-Grey

KANAT GENİŞLİĞİ SASH WIDTH	KANAT YÜKSEKLİĞİ SASH HEIGHT	KANAT AĞIRLIĞI SASH WEIGHT	GIESSE ÇİFT AÇILIM SETİ GIESSE TILT & TURN MECHANISM	ÇİFT AÇILIM SETİ TILT & TURN MECHANISM
410- 569 mm	600-1200 mm	80 kg	07.06.62	Çift Açılım Seti Tip 1 / Tilt & Turn Mechanism
410- 569 mm	1201-2500 mm	80 kg	07.06.63	Çift Açılım Seti Tip 1 + Arka Kilitleme / Tilt & Turn Mechanism Style 1+ Additional Tilt&Turn (Back)
570-1000 mm	600-1200 mm	80 kg	07.06.64	Çift Açılım Seti Tip 2 / Tilt & Turn Mechanism Style 2
570-1000 mm	1201-2500 mm	80 kg	07.06.65	Çift Açılım Seti Tip 2 + Arka Kilitleme / Tilt & Turn Mechanism Style 2+ Additional Tilt&Turn (Back)
1001-1700 mm	600-1200 mm	80 kg	07.06.66	Çift Açılım Seti Tip 2 + Alt Kilitleme +İlave Makas / Tilt & Turn Mechanism Style 2+ Additional Tilt&Turn (Down) + Additional Arm
1001-1700 mm	1201-2500 mm	80 kg	07.06.67	Çift Açılım Seti Tip 2 + Alt Kilitleme +Arka Kilitleme+İlave Makas / Tilt & Turn Mechanism Style 2+ Additional Tilt&Turn (Down)+ Additional Tilt&Turn (Back)+ Additional Arm





GIESSE GİZLİ MENTEŞE ÇİFT AÇILIM SETİ 100 kg
GIESSE HIDDEN HINGE TILT & TURN MECHANISM 100 kg

Renk / Colour : Siyah-Beyaz-Gri
Black-White-Grey

KANAT GENİŞLİĞİ SASH WIDTH	KANAT YÜKSEKLİĞİ SASH HEIGHT	KANAT AĞIRLIĞI SASH WEIGHT	GIESSE ÇİFT AÇILIM SETİ GIESSE TILT & TURN MECHANISM	GIESSE GİZLİ MENTEŞE ÇİFT AÇILIM SETİ GIESSE HIDDEN HINGE TILT & TURN MECHANISM
600-1000 mm	600-1200 mm	100 kg	07.06.81	Gizli Menteşe Çift Açılım Seti Sağ /Hidden Hinge Tilt & Turn Mechanism Right
600-1000 mm	600-1200 mm	100 kg	07.06.82	Gizli Menteşe Çift Açılım Seti Sol /Hidden Hinge Tilt & Turn Mechanism Left
600-1000 mm	1201-2500 mm	100 kg	07.06.83	Gizli Menteşe Çift Açılım Seti Sağ+İlave Kilit /Hidden Hinge Tilt & Turn Mechanism Right+ Additional Locking
600-1000 mm	1201-2500 mm	100 kg	07.06.84	Gizli Menteşe Çift Açılım Seti Sol+İlave Kilit /Hidden Hinge Tilt & Turn Mechanism Left+ Additional Locking
1001-1700 mm	600-1200 mm	100 kg	07.06.85	Gizli Menteşe Çift Açılım Seti Sağ+İlave Kilit /Hidden Hinge Tilt & Turn Mechanism Right+ Additional Locking
1001-1700 mm	600-1200 mm	100 kg	07.06.86	Gizli Menteşe Çift Açılım Seti Sol+İlave Kilit /Hidden Hinge Tilt & Turn Mechanism Left+ Additional Locking
1001-1700 mm	1201-2500 mm	100 kg	07.06.87	Gizli Menteşe Çift Açılım Seti Sağ+İlave Kilit (2 Adet) /Hidden Hinge Tilt & Turn Mechanism Right+ Additional Locking (2 Unit)
1001-1700 mm	1201-2500 mm	100 kg	07.06.88	Gizli Menteşe Çift Açılım Seti Sol+İlave Kilit (2 Adet) /Hidden Hinge Tilt & Turn Mechanism Left+ Additional Locking (2 Unit)

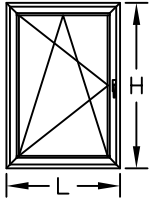
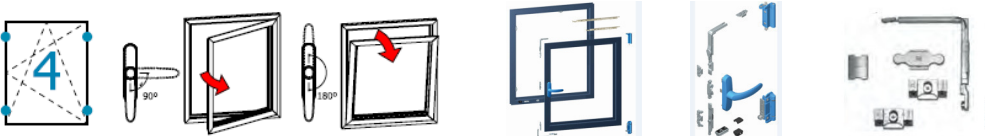
ÇİFT EKSEN MEKANİZMALARI / TILT & TURN MECHANISMS

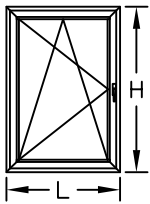
	<p>RESCARA ÇİFT AÇILIM SETİ 130 kg RESCARA TILT & TURN MECHANISM 130 kg Renk / Colour : Siyah-Beyaz-Gri Black-White-Grey</p>					
						
KANAT GENİŞLİĞİ SASH WIDTH L (m)	KANAT YÜKSEKLİĞİ SASH HEIGHT H (m)	KANAT AĞIRLIĞI SASH WEIGHT KG	MEKANİZMA MECHANISM	MAKAS ARM	İLAVE KİLİTLEME ADDITIONAL LOCKING	İLAVE MAKAS ADDITIONAL ARM
563-1000 mm	600-1200 mm	130 kg	07.06.79	07.06.80	—	—
563-1000 mm	1200-2500 mm	130 kg	07.06.79	07.06.80	07.06.76	—
1000-1700 mm	600-1200 mm	130 kg	07.06.79	07.06.80	07.06.76	07.06.77
1000-1700 mm	1200-2500 mm	130 kg	07.06.79	07.06.80	07.06.76 (2 ADET)	07.06.77

	<p>RESCARA AKILLI ÇİFT AÇILIM SETİ 130 kg RESCARA TBT TILT & TURN MECHANISM 130 kg Renk / Colour : Siyah-Beyaz-Gri Black-White-Grey KOL ANAHTARLIDIR / HANDLE WITH KEYLOCK</p>					
						
KANAT GENİŞLİĞİ SASH WIDTH L (m)	KANAT YÜKSEKLİĞİ SASH HEIGHT H (m)	KANAT AĞIRLIĞI SASH WEIGHT KG	MEKANİZMA MECHANISM	MAKAS ARM	İLAVE KİLİTLEME ADDITIONAL LOCKING	İLAVE MAKAS ADDITIONAL ARM
563-1000 mm	600-1200 mm	130 kg	07.06.74 (TBT)	07.06.75 (TBT)	—	—
563-1000 mm	1200-2500 mm	130 kg	07.06.74 (TBT)	07.06.75 (TBT)	07.06.76	—
1000-1700 mm	600-1200 mm	130 kg	07.06.74 (TBT)	07.06.75 (TBT)	—	07.06.77
1000-1700 mm	1200-2500 mm	130 kg	07.06.74 (TBT)	07.06.75 (TBT)	07.06.76	07.06.77

PVC KANAL İÇİN AÇILIM SETLERİ / OPENING SETS FOR PVC CHANNEL



07.05.41

RESCARA AKUSTİK PENCERE KOLU
RESCARA ACOUSTIC HANDLE

Renk / Colour : Siyah-Beyaz-Gri
Black-White-Grey





07.05.42



RESCARA AKUSTİK PENCERE KOLU
RESCARA ACOUSTIC HANDLE

Renk / Colour : Siyah-Beyaz-Gri
Black-White-Grey

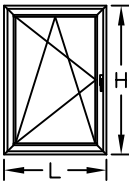
*KOL SETE DAHİL DEĞİLDİR.
HANDLE IS NOT INCLUDED IN THE SET.

*KOL SEÇENEKLERİ; 07.05.41 - 07.05.42
HANDLE OPTIONS; 07.05.41 - 07.05.42

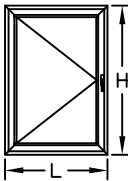
PVC KANALLI ÇİFT AÇILIM SETİ 80 kg TILT & TURN MECHANISM FOR PVC CHANNEL 80 kg Renk / Colour : Siyah-Beyaz-Gri Black-White-Silver				
				
KANAT GENİŞLİĞİ SASH WIDTH L (mm)	KANAT YÜKSEKLİĞİ SASH HEIGHT H (mm)	KANAT AĞIRLIĞI SASH WEIGHT (KG)	SAĞ RIGHT	SOL LEFT
501-750 mm	951-1450 mm	80 kg	07.30.01	07.30.02
501-750 mm	1451-1950 mm	80 kg	07.30.05	07.30.06
501-750 mm	1951-2450 mm	80 kg	07.30.07	07.30.08
751-1000 mm	951-1450 mm	80 kg	07.30.09	07.30.10
751-1000 mm	1451-1950 mm	80 kg	07.30.13	07.30.14
751-1000 mm	1951-2450 mm	80 kg	07.30.15	07.30.16
1001-1200 mm	951-1450 mm	80 kg	07.30.17	07.30.18
1001-1200 mm	1451-1950 mm	80 kg	07.30.21	07.30.22
1001-1200 mm	1951-2450 mm	80 kg	07.30.23	07.30.24
1201-1450 mm	951-1450 mm	80 kg	07.30.25	07.30.26
1201-1450 mm	1451-1950 mm	80 kg	07.30.29	07.30.30
1201-1450 mm	1951-2450 mm	80 kg	07.30.31	07.30.32
1451-1600 mm	951-1450 mm	80 kg	07.30.33	07.30.34
1451-1600 mm	1451-1950 mm	80 kg	07.30.37	07.30.38
1451-1600 mm	1951-2450 mm	80 kg	07.30.39	07.30.40

PVC KANALLI TEK AÇILIM SETİ 80 kg SIDE HUNG OPENING SET FOR PVC CHANNEL 80 kg Renk / Colour : Siyah-Beyaz-Gri Black-White-Silver			
			
KANAT YÜKSEKLİĞİ SASH HEIGHT H (mm)	KANAT AĞIRLIĞI SASH WEIGHT (KG)	SAĞ RIGHT	SOL LEFT
501-600 mm	80 kg	07.27.01	07.27.02
601-800 mm	80 kg	07.27.03	07.27.04
801-900 mm	80 kg	07.27.05	07.27.06
901-1000 mm	80 kg	07.27.07	07.27.08
1001-1100 mm	80 kg	07.27.09	07.27.10
1101-1200 mm	80 kg	07.27.11	07.27.12
1201-1300 mm	80 kg	07.27.13	07.27.14
1301-1400 mm	80 kg	07.27.15	07.27.16
1401-1600 mm	80 kg	07.27.17	07.27.18
1601-1800 mm	80 kg	07.27.19	07.27.20
1801-2000 mm	80 kg	07.27.21	07.27.22
2000-2200 mm	80 kg	07.27.23	07.27.24

*PVC KANALLI TEK AÇILIM SETİ İÇİN KANAT GENİŞLİĞİ L<1000MM OLMALIDIR.
DAHA BÜYÜK ÖLÇÜLER İÇİN İRTİBATA GEÇEBİLİRSİNİZ.
PERIMETRIC GROOVE (16MM) SIDE HUNG OPENING KIT FOR L<1000MM.
FOR L>1000MM PLEASE CONTACT TECHNICAL OFFICE.

PENCERE KOLLARI / WINDOW HANDLES



07.05.25

GIESSE İSPANYOLET KOL (ÇİFT DİLLİ)
GIESSE HANDLE FOR WINDOWS (DOUBLE RAIL)

Renk / Colour : Siyah-Beyaz-Gri
Black-White-Grey

UNI CEI EN ISO / IEC 17050



07.05.33

GIESSE ANAHTARLI İSPANYOLET KOL (ÇİFT DİLLİ)

GIESSE KEY HANDLE FOR WINDOWS (DOUBLE RAIL)

Renk / Colour : Siyah-Beyaz-Gri
Black-White-Grey

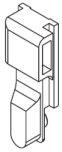
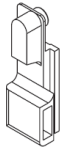

07.25.01

GIESSE TIJ BAĞLANTI PARÇASI
GIESSE CONNECTION ROD

Renk / Colour : Siyah / Black
Malzeme / Material : Polyamid / Polyamide

07.05.25 , 07.05.33 ve 07.05.34 Kol için / For Handle 07.05.25 , 07.05.33 and 07.05.34



07.05.34

GIESSE SÖKÜLEBİLİR KOL GÖVDESİ (ÇİFT DİLLİ)

GIESSE REMOVABLE HANDLE BODY (DOUBLE RAIL)

Renk / Colour : Siyah-Beyaz-Gri
Black-White-Grey



07.05.29

RESCARA GLOBAL ANAHTARLI PENCERE KOLU (TEK DİLLİ)
RESCARA GLOBAL KEY HANDLE FOR WINDOWS (SINGLE RAIL)

Renk / Colour : Siyah-Beyaz-Gri
Black-White-Grey

EN 1670



07.05.35

GIESSE SÖKÜLEBİLİR KOL
GIESSE REMOVABLE HANDLE

Renk / Colour : Siyah
Black



07.13.07

RESCARA KOL BAĞLANTI PARÇASI
RESCARA CONNECTION PART FOR HANDLE

Malzeme / Material : Zamak / Zamak

07.05.29 Kol için / For Handle 07.05.29



07.05.30

RESCARA GLOBAL SÖKÜLEBİLİR KOL GÖVDESİ (ÇİFT DİLLİ)
RESCARA GLOBAL REMOVABLE HANDLE BODY (DOUBLE RAIL)

Renk / Colour : Siyah-Beyaz-Gri
Black-White-Grey

EN 1670



07.05.28

RESCARA GLOBAL PENCERE KOLU (TEK DİLLİ)
RESCARA GLOBAL HANDLE FOR WINDOWS (SINGLE RAIL)

Renk / Colour : Siyah-Beyaz-Gri
Black-White-Grey

EN 1670



07.05.31

RESCARA SÖKÜLEBİLİR KOL
RESCARA REMOVABLE HANDLE

Renk / Colour : Siyah / Black

EN 1670



07.05.32

RESCARA GLOBAL PENCERE KOLU (ÇİFT DİLLİ)
RESCARA GLOBAL HANDLE FOR WINDOWS (DOUBLE RAIL)

Renk / Colour : Siyah-Beyaz-Gri
Black-White-Grey

EN 1670, 13126-8



07.13.08

RESCARA KOL BAĞLANTI PARÇASI
RESCARA CONNECTION PART FOR HANDLE

Renk / Colour : Siyah / Black
Malzeme / Material : PVC

07.05.28, 07.05.30 ve 07.05.32 Kol için / For Handle 07.05.28, 07.05.30 and 07.05.32

İSPANYOLET KİLİTLEME PARÇALARI / LOCKING KITS



07.13.03

PİM
LOCK PIN
Malzeme / Material : Zamak / Zamak



07.13.06

GIESSE PİM
GIESSE ADJUSTABLE LOCKING PAWL

Malzeme / Material : Zamak / Zamak

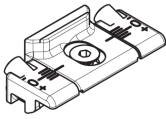

07.09.07

GIESSE AYARLI PİM KARŞILIĞI
GIESSE ADJUSTABLE SINGLE STRIKER

Malzeme / Material : Zamak / Zamak

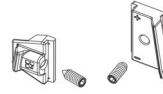

07.09.08

GIESSE ARKA KİLİTLEME
GIESSE BURGLAR BOLT

Malzeme / Material : Zamak / Zamak



18.07.01

GIESSE SÜRGÜ SETİ
GIESSE BOLT FOR LEAF

Malzeme / Material : Zamak ve polyamid
Zamak and polyamide

Pasif kanat için / For secondary sash



07.09.11

RESCARA SABİT KARŞILIK
RESCARA FIXED STRIKER

Malzeme / Material : Zamak / Zamak

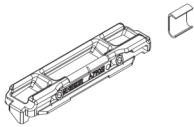

18.06.01

GIESSE KARŞILIK
GIESSE STRIKER

Malzeme / Material : Paslanmaz çelik ve zamak
Stainless steel and zamak



07.09.12

RESCARA AYARLI KARŞILIK
RESCARA ADJUSTABLE STRIKER

Malzeme / Material : Zamak / Zamak



07.09.13

RESCARA ARKA KİLİTLEME
RESCARA BURGLAR BOLT

Malzeme / Material : Zamak / Zamak



07.21.02

GIESSE KÖŞE DÖNME
GIESSE CORNER DRIVE

Malzeme / Material : Zamak / Zamak



07.21.03

RESCARA KÖŞE DÖNME
RESCARA CORNER DRIVE

Malzeme / Material : Zamak / Zamak



07.06.78

RESCARA MICROVENTİLASYON
RESCARA MICROVENTILATION

Malzeme / Material : Zamak / Zamak

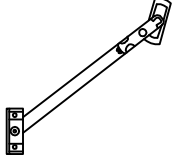

07.07.02

VASİSTAS MAKAS
ARM FOR BOTTOM-HUNG WINDOWS

Renk / Colour : Siyah-Beyaz-Gri
Black-White-Grey

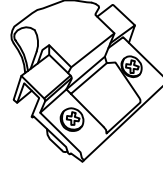

07.08.01

RESCARA VASİSTAS MANDAL
RESCARA DEVICE FOR CLOSING BOTTOM-HUNG WINDOWS

Renk / Colour : Siyah-Beyaz-Gri
Black-White-Grey



07.07.08

SINIRLAYICI MAKAS
LIMITER

Malzeme / Material : Gümüş- Paslanmaz Çelik
Silver - Stainless Steel



07.07.09

GIESSE VASİSTAS MAKAS
GIESSE ARM FOR BOTTOM-HUNG WINDOWS

Renk / Colour : Siyah-Beyaz-Gri
Black-White-Grey

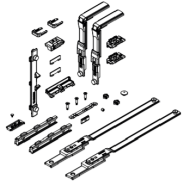

07.07.11

GIESSE VASİSTAS PENCERE SETİ
GIESSE BOTTOM HUNG WINDOW SET

Kol ve menteşe sete dahil değildir.
Handle and hinge is not included in the set



11.02.34

RESCARA KANAT DESTEK TAKOZU
RESCARA VENT SUPPORT PIECE

Malzeme / Material : PVC
Renk / Colour : Siyah/Black

ÇİFT DİLLİ KOL VE KİLİTLEME SETİ SEÇİM TABLOSU DOUBLE RAILED HANDLE AND LOCKING KIT TABLE

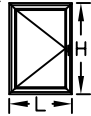

KOD CODE	AÇIKLAMA DESCRIPTION	ÜRÜN RESMİ PRODUCT IMAGE	TEMELE SET MAIN SET		
			H<1200mm L<1000mm	1200mm < H < 2700 mm	1000mm < L < 1400 mm
07.05.25	GIESSE ÇİFT DİLLİ KOL GIESSE DOUBLE RAIL HANDLE		1		
07.25.01	GIESSE KOL BAĞLANTISI GIESSE ROD CONNECTION PIECES		1		
07.13.06	GIESSE AYARLI PİM GIESSE ADJUSTABLE LOCKING PAWL		2	2	2
07.09.11	RESCARA SABİT KARŞILIK RESCARA FIXED STRIKER		2	2	2
07.09.07	GIESSE AYARLI PİM KARŞILIĞI GIESSE ADJUSTABLE SINGLE STRIKER				2
07.21.02	GIESSE KÖŞE DÖNME GIESSE/RESCARA CORNER DRIVE				2
11.02.34	RESCARA KANAT DESTEK TAKOZU RESCARA VENT SUPPORT PIECE		1		

***Giesse kol ve kilitleme aksesuarları 25 I 07 tij profili ile kullanılmalıdır.
Giesse handle and locking accessories should be used with 25 I 07 rod profile

TEK DİLLİ KOL VE KİLİTLEME SETİ SEÇİM TABLOSU
SINGLE RAILED HANDLE AND LOCKING KIT TABLE

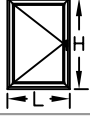

KOD CODE	AÇIKLAMA DESCRIPTION	ÜRÜN RESMİ PRODUCT IMAGE	TEMELE SET MAIN SET		
			H<1200mm L<1000mm	1200mm < H < 2700 mm	1000mm < L < 1400 mm
07.05.28 07.05.29	RESCARA TEK DİLLİ KOL GIESSE DOUBLE RAIL HANDLE		1		
07.13.07	RESCARA KOL BAĞLANTI PARÇASI RESCARA CONNECTION PART FOR HANDLE		1		
07.13.06	GIESSE AYARLI PİM GIESSE ADJUSTABLE LOCKING PAWL		2	2	2
07.09.11	RESCARA SABİT KARŞILIK RESCARA FIXED STRIKER		2	2	2
07.09.12	RESCARA AYARLI KARŞILIK RESCARA ADJUSTABLE STRIKER				2
07.21.03	RESCARA KÖŞE DÖNME RESCARA CORNER DRIVE				2
11.02.34	RESCARA KANAT DESTEK TAKOZU RESCARA VENT SUPPORT PIECE		1		

ÇİFT/TEK AÇILIM PASİF KANAT AKSESUAR SEÇİM TABLOSU
SECONDARY SASH LOCKING KIT TABLE

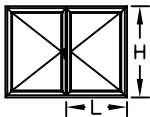

KOD CODE	AÇIKLAMA DESCRIPTION	ÜRÜN RESMİ PRODUCT IMAGE	TEMELE SET MAIN SET		
			H<1200mm L<1000mm	1200mm < H < 2700 mm	1000mm < L < 1400 mm
18.07.01	GIESSE SÜRGÜ SETİ GIESSE BOLT FOR LEAF		1		
18.06.01	GIESSE KARŞILIK GIESSE STRIKER		2		
07.21.02	GIESSE KÖŞE DÖNME PARÇASI GIESSE CORNER DRIVE				2
07.09.07	GIESSE AYARLI PİM KARŞILIĞI GIESSE ADJUSTABLE SINGLE STRIKER				2
07.09.08	GIESSE ARKA KİLİTLEME GIESSE BURGLAR BOLT			1	

***Giesse kol ve kilitleme aksesuarları 25 I 07 tij profili ile kullanılmalıdır.
Giesse handle and locking accessories should be used with 25 I 07 rod profile

KAPI KOLLARI / DOOR HANDLES



07.14.06

GIESSE KAPI KOLU
GIESSE DOOR HANDLE

Renk / Colour : Siyah-Beyaz-Gri
Black-White-Grey



07.14.07

RESCARA GLOBAL KAPI KOLU
RESCARA GLOBAL DOOR HANDLE

Renk / Colour : Siyah-Beyaz-Gri
Black-White-Grey



07.14.08

RESCARA MULETA KAPI KOLU
RESCARA GLOBAL DOOR HANDLE

Renk / Colour : Siyah-Beyaz-Gri
Black-White-Grey

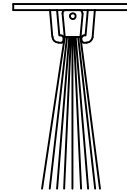

17.02.01

KAPI ALTI FIRÇASI
BRUSH FOR DOORS

Malzeme / Material : Polipropilen / Polypropylene

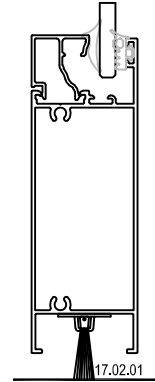

Ölçek/Scale: 1:1

KAPI KOLLARI / DOOR HANDLES

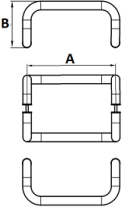
		KIVRIK KOL DOOR HANDLE Renk / Colour : Siyah-Beyaz-Eloksal Black-White-Anodised	
KOD CODE	Ø (mm)	A (mm)	B (mm)
07.17.10	25	200	130
07.17.11	25	300	130
07.17.02	25	400	130
07.17.27	25	500	160

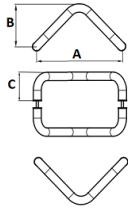
		V KOL DOOR HANDLE Renk / Colour : Siyah-Beyaz-Eloksal Black-White-Anodised		
KOD CODE	Ø (mm)	A (mm)	B (mm)	C (mm)
07.17.06	25	200	130	80
07.17.29	25	250	130	80
07.17.30	25	300	130	80
07.17.31	30	400	160	100

		U KOL DOOR HANDLE Renk / Colour : Siyah-Beyaz-Eloksal Black-White-Anodised	
KOD CODE	Ø (mm)	A (mm)	B (mm)
07.17.08	25	200	80
07.17.35	25	300	80
07.17.36	30	400	100

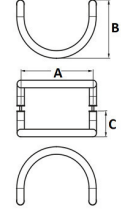
		YARIM AY KOL DOOR HANDLE Renk / Colour : Siyah-Beyaz-Eloksal Black-White-Anodised		
KOD CODE	Ø (mm)	A (mm)	B (mm)	C (mm)
07.17.32	25	200	130	80
07.17.20	25	300	130	80
07.17.33	30	350	160	100

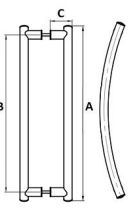
		YAY KOL DOOR HANDLE Renk / Colour : Siyah-Beyaz-Eloksal Black-White-Anodised	
KOD CODE	Ø (mm)	A (mm)	B (mm)
07.17.37	400	350	80
07.17.22	500	450	80
07.17.38	600	550	80
07.17.39	700	650	80
07.17.40	800	750	80

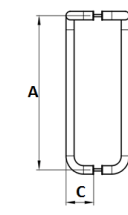
		BASTON KOL DOOR HANDLE Renk / Colour : Siyah-Beyaz-Eloksal Black-White-Anodised		
KOD CODE	Ø (mm)	A (mm)	B (mm)	C (mm)
07.17.23	25	900	180	80
07.17.34	25	1000	180	80



07.17.19
AKBANK KAPI KOLU
DOOR HANDLE
Renk / Colour : Siyah-Beyaz-Gri-Eloksal
Black-White-Grey-Anodised



07.13.10
AKBANK KOL APARATI
DOOR HANDLE
Renk / Colour : Siyah-Beyaz-Gri-Eloksal
Black-White-Grey-Anodised

KAPI KİLİTLERİ / DOOR LOCKS



18.01.01
MAKARALI KİLİT
MORTISE LOCK (WITH ROLLER)

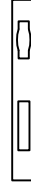

18.02.21
MAKARALI KİLİT KARŞILIĞI
STRIKER FOR ROLLER LOCK



18.01.02
DİLLİ KİLİT
MORTISE LOCK

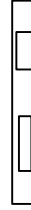

18.02.20
DİLLİ KİLİT KARŞILIĞI
STRIKER FOR MORTISE LOCK



18.03.01
KAPI SÜRGÜSÜ (UZUN)
BOLT FOR DOORS (LONG)



18.03.06
KAPI SÜRGÜSÜ (KISA)
BOLT FOR DOORS (SHORT)

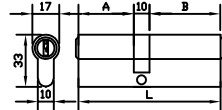

18.04.03
BAREL
CYLINDER
Malzeme / Material : Krom-Nikel / Chrome-Nickel

A	B	L
26	32	68



18.05.02
BAREL AYNASI
CYLINDER COVER
Renk / Colour : Siyah-Beyaz-Grey
Black-White-Grey

